

# S4L120F



Product Family	Refrigerator
Installation	Built-in
Category	One Door
Built-in niche	122
Reference width	Until 60
Reference height	100 - 160
Cooling type	Static
Defrost	Automatic
Hinge type	Sliding
Hinge position	Right
Reversible door	Yes
EAN code	8017709295424



## Aesthetics

Aesthetic	Universal	Cor do perfil das prateleiras da porta	White
Colour	White	Cor do perfil das gavetas	White
Design	Flat	Cor do perfil da prateleira de vidro	White
Material	Metal sheet	Display	No
Side material	Steel	Dispenser	No
Side colour	White	Water Filter	No
Logotipo	Logotipo serigrafado	HomeBar	No

## Refrigerator compartment features



No. of adjustable shelves	4	Type of crisper/vegetable drawers cover	Glass
Number of fruit and vegetables drawers	1	Life Plus zone-0°C	No
Type of adjustable shelves	Glass	Compartimento baixa temperatura	No
Type of crisper/vegetable drawers cover	Standard	Internal light in fridge	Yes
Crisper Cover	Yes	Type of internal light (fridge)	LED
Bottle shelf	No		

## Refrigerator Inner Door

<b>Number of adjustable door shelves</b>	3	<b>No. of bottle shelves</b>	1
<b>Adjustable door shelves with wire support</b>	No	<b>Bottle shelves with wire support</b>	No

## Other Refrigerator features

<b>Accessories</b>	Kit listeria, Egg tray	<b>Fan</b>	No
<b>Natural Plus Blu Light</b>	No	<b>Ionizer</b>	No
<b>MultiFlow</b>	No		

## Freezer compartment features

<b>Internal freezer compartment</b>	No
-------------------------------------	----

## Other technical features

<b>Ligação à rede de água</b>	No
<b>Power on lamp</b>	No
<b>Temperature alarm lamp</b>	No
<b>Door open alarm</b>	No
<b>Temperature Alarm</b>	No
<b>Type of temperature control</b>	Electro-mechanical
<b>No. of compressors</b>	1
<b>Refrigerant gas type</b>	R600a
<b>Type of compressor</b>	Standard
<b>Refrigerant Quantity (gr)</b>	25 g
<b>Espuma expansiva de isolamento</b>	Ciclopentano

## Etiqueta de Desempenho / Energia - Reg. 2019

			
<b>Consumo de energia anual</b>	127 kWh/a	<b>Airborne acoustical noise emissions</b>	35 dB(A) re 1 pW
<b>Classe de eficiência energética</b>	F	<b>Autonomia de conservação sem energia elétrica</b>	0.00 h
<b>Classe de emissão de ruído acústico aerotransportado</b>	B	<b>Capacidade bruta do Refrigerador</b>	208 l
<b>Volume líquido total</b>	208 l	<b>Classe climática</b>	SN, N, ST, T
<b>Soma dos volumes do(s) compartimento(s) refrigerado(s) e do(s) compartimento(s) não congelado(s)</b>	208 l	<b>EEl</b>	125 %



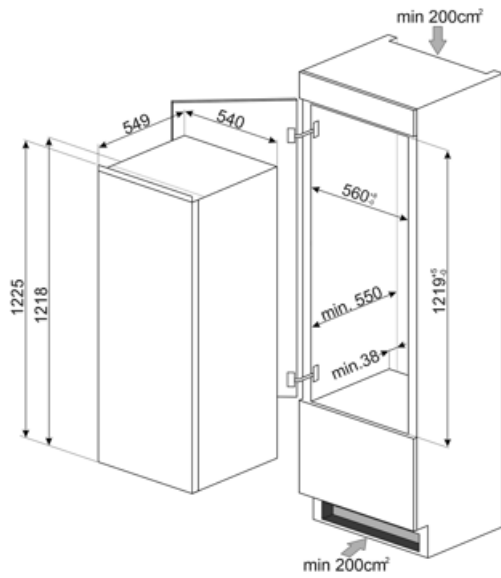

## Electrical Connection

---

Plug	(F;E) Schuko	Voltage (V)	230-240 V
Electrical connection rating	130 W	Frequency (Hz)	50 Hz
Current	1 A	Power supply cable length	240 cm



## Symbols glossary

-  O sistema de descongelamento automático funciona descongelando automaticamente em intervalos regulares, eliminando a necessidade de descongelar completamente.
-  Classe de eficiência energética F
-  Nicho incorporado
-  A+: A classe de eficiência energética A+ ajuda a economizar até 10% de energia em comparação com a classe A. O desempenho máximo com consumo mínimo é garantido.
-  Iluminação interior LED: é uma forma mais eficiente em termos energéticos e duradoura de iluminar o interior do aparelho.

---

## Benefit (TT)

---

### **Refrigerant gas R600a**

Environmentally friendly R600a refrigerant gas contributes to rapid cooling with lower energy consumption

### **Climate class**

Climatic class SN-T makes the appliance suitable for working at room temperature between 10 °C and 43 °C (50 °F ~ 109 °F)

### **Refrigerator Internal lighting**

Interior lighting for perfect visibility of shelves in the refrigerator compartment

### **Fruit and vegetable drawer**

The fruit and vegetable drawer ensures the best storage conditions for fresh food, avoiding any contamination