

S8C124DE1

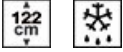

Product Family	Refrigerator
Installation	Built-in
Category	One Door
Built-in niche	122
Reference width	Until 60
Reference height	100 - 160
Cooling type	Static
Defrost	Automatic for refrigerator, manual for freezer
Hinge type	Door on door
Hinge position	Right
Reversible door	Yes
EAN code	8017709319328



Aesthetics



Aesthetic	Universale	Door shelves profile color	Silver
Colour	White	Drawers profile color	Silver
Design	Flat	Color of glass shelf profile	Chrome
Side material	Steel	Display	LCD Touch
Side colour	White	Display position	Interno (sul Top)
Logo	Silk screen		

Refrigerator compartment features



No. of adjustable shelves	3	Crisper Cover	Yes
Number of fruit and vegetables drawers	2	Type of crisper/vegetable drawers cover	Glass
Type of adjustable shelves	Glass	Internal light in fridge	Yes
Type of crisper/vegetable drawers cover	Standard	Type of internal light (fridge)	LED

Refrigerator Inner Door

No. of door shelves with transparent cover	1	No. of bottle shelves	1
---	---	------------------------------	---

Number of adjustable door shelves 2

Other Refrigerator features

Accessories Egg tray

Freezer compartment features

Internal freezer compartment Yes

Other technical features



Functions display

Fast freezing, Fast cooling, Control lock, Temperature alarm, Cooling timer

Temperature alarm lamp

Yes

Door open alarm

Yes

Temperature Alarm

Yes

Type of temperature control

Electronic

No. of compressors

1

Refrigerant gas type

R600a

Type of compressor

Standard

Max weight door panel (fridge)

18 kg

Foam agent

Cyclopentane

Performance / Energy Label - Reg. 2019



Annual energy consumption 156 kWh/a

Energy efficiency class E

Airborne acoustical noise emission class B

Total net volume 181 l

Sum of the volumes of the frozen compartment(s) 14 l

Sum of the volumes of the chill compartment(s) and the unfrozen compartment(s) 167 l

Airborne acoustical noise emissions 35 dB(A) re 1 pW

Gross volume frozen food compartment 15 l

Temperature Rise Time 9.80 h

Fresh Food compartment - Gross Volume 170 l

4 star - Freezing capacity 2.6 Kg/24h







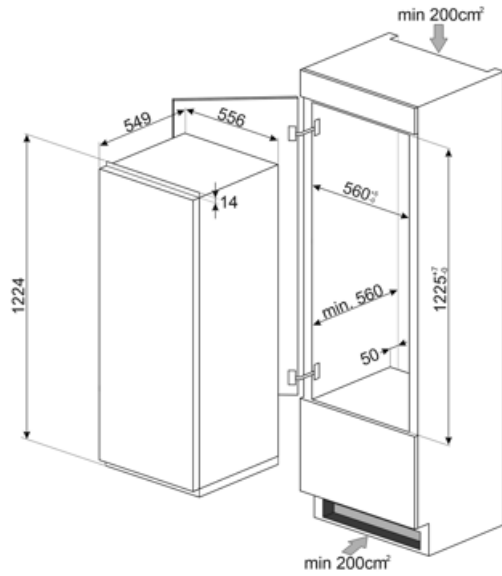

Climate class SN, N, ST
EEI 100 %

Electrical Connection

Plug	(F;E) Schuko	Voltage (V)	230-240 V
Electrical connection rating	130 W	Frequency (Hz)	50 Hz
Current	1 A	Power supply cable length	240 cm



Symbols glossary (TT)

	4 stars freezing compartment for better food preservation.		The automatic defrost system works by automatically defrosting at regular intervals eliminating the need to defrost altogether.
	Child lock: some models are fitted with a device to lock the programme/cycle so it cannot be accidentally changed.		LCD display: to optimize performance and simplify the use of the appliance.
	Fast freezing: The fast freezing function brings the temperature of the compartment down when activated a few hours prior to usage.		LED interior lighting: is a more energy efficient and long lasting way of illuminating the interior of the appliance.
	Built-in niche		Energy efficiency class E