

SAB4304X

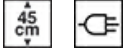

Product Family
Category
Vitality system
Power supply
Cooling type

Blast chiller
45cm compact
Yes
Electric
Fan assisted





Aesthetics

Aesthetics	Classic	Type of steel	Brushed
Colour	Stainless steel	Glass Type	Eclipse
Finishing	Fingerproof	Door	With 2 horizontal strips
Design	Flat	Handle	Classic
Component finish	Stainless steel	Handle Colour	Steel effect
Material	Stainless steel	Logo	Embossed

Program / Functions



Automatic programmes	52
No. of warming functions	5
N. cold functions	5
Automatic cleaning	

Cold functions

 Bottles Cooling	 Cooling	 Deep Freezing
--	---	---

 Pre-cooling	 Preservation
--	--

Warming functions

 Low Temperature Cooking	 Defrost by time	 Proving
--	---	---

 Ready to eat	 Defrost by weight
---	---

Controls



Display / Clock	TFT graphic , colour touch screen	Display languages	IT, EN, FR, NL, SP, PT, SWE, RU, DE, DA, NO, PL, FI
No. of display languages	13	Control setting	Touch control

Options



Door open alarm	Yes	Cooking with probe thermometer	Yes
Minute minder	Electronic	Cooling with probe	Yes
Timer	1	Showroom demo option	Yes
Controls Lock / Child Safety	Yes	Tones	Standard
Other options	Child lock, Clock settings, Demo Mode, Language setting, Digital clock display, Tones	History	Yes, the last 10 functions utilised

Technical Features

Type of compressor	Standard	No. of lights	1
Refrigerant gas type	R290	Light type	Halogen
Refrigerant Quantity	130 g	Light power	20 W
Noise level	48 dBA	Light when door is opened	Yes
Temperature control	Electronic	Upper heating element - Power	250 W
Minimum Temperature	-35 °C	Door opening type	Standard opening
Maximum temperature	75 °C	Safety Thermostat	Yes
Cavity material	Stainless steel	Heating suspended when door is opened	Yes
Shelf positions	3	Usable cavity space dimensions (HxWxD)	225 x 475 x 360 mm
Shelves type	Metal racks		

Accessories Included

Grid with back stop	1	Other	Microfiber cloth
Temperature probe	Yes		

Electrical Connection

Voltage	220-240 V	Current	2,5 A
Plug	(F;E) Schuko	Frequency (Hz)	50 Hz

Nominal power (W) 270 W

Power supply cable length 200 cm

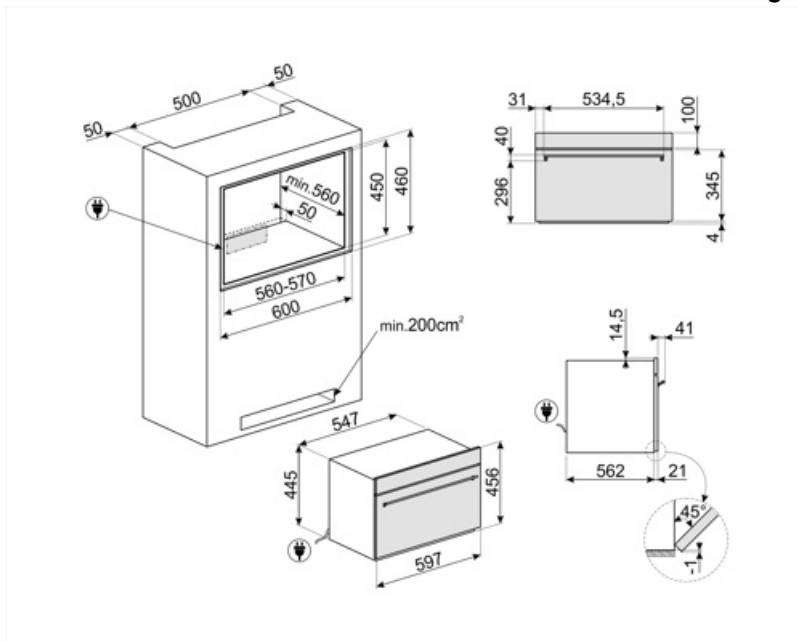



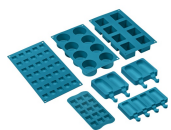













Compatible Accessories



SMOLD

Set of 7 silicone moulds for ice creams, ice lollies, pralines, ice cubes or to portion food. Usable from -60°C to +230°C

Symbols glossary

 <p>Child lock: some models are fitted with a device to lock the programme/cycle so it cannot be accidentally changed.</p>	 <p>Cooling: It allows to quickly cool the food, from the temperature of 80/90°C to 3°C in less than 90 minutes, to prevent bacterial growth, prolong the average life of food and maintain unaltered the quality of food.</p>
 <p>Cold storage: allows to keep the food at the desired temperature between -35°C and +75°C and serve it at its best to enhance flavours and aromas.</p>	 <p>Pre-cooling: allows the cavity to cool to -30 °C before inserting food into the blast chiller, to ensure the best cooling and freezing results. It is recommended to run a 15-minute pre-cooling cycle.</p>
 <p>Bottles cooling: is possible to quickly cool wine and beverage bottles, reducing the need for storage in the refrigerator, with considerable space savings. Cooling of beverages takes place at about 1°C per minute.</p>	 <p>Deep freezing of the food is a very quick process (From 0/90°C temperature to -18°C in less than 270 min) that allows to extend the average life of food (by up to 70% more) and keep the same organoleptic and nutritional characteristics of fresh food, because it avoid the formation of macro-crystals, that ruin the fibers of the food.</p>
 <p>Electric</p>	 <p>Fingerprint proof stainless steel: Fingerprint proof stainless steel keeps stainless steel looking as good as new.</p>
 <p>Automatic cleaning: a drying cycle of the cavity to be run with the door open, to eliminate any condensation formed during use.</p>	 <p>Compact appliances with a height of 45 cm - perfect solution to meet the functional requirements of kitchen sets of small height. Available in several types and in different styles.</p>
 <p>Touch controls: Easy to use touch controls allow the appliance to be programmed at the touch of a button.</p>	 <p>Ready to eat: This function allows to keep food safely at the refrigerator temperature throughout the day, and heat it just before your return to make it warm, ready to be consumed.</p>
 <p>Low temperature cooking: This function consists in cooking food at a constant temperature, lower than the traditional cooking temperature. Meat results more tender and juicy, maintaining a softness that only this cooking technique allows to obtain.</p>	 <p>Dough leavening/ Yogurt: this function allows you to create the perfect conditions for correct leavening, keeping the mixture at controlled temperatures for the desired time, avoiding sudden changes in humidity levels. This feature also allows the creation of genuine homemade yogurt.</p>
 <p>Thawing by time or by weight: is possible to defrost foods quickly and evenly, without cook the food partially and affect its protein content and with inevitably compromise the quality. The process controls the temperature, preserving the natural moisture and fragrance of the food.</p>	 <p>Thawing by time or by weight: is possible to defrost foods quickly and evenly, without cook the food partially and affect its protein content and with inevitably compromise the quality. The process controls the temperature, preserving the natural moisture and fragrance of the food.</p>