

SAB4304X



Familie
Categorie
Vitality system
Voeding
Type koeling

Blast chiller
Compact 45 cm
Ja
Elektrisch
Geventileerd



Design

Esthetiek	Classici	Type roestvrijstaal	Geborsteld
Kleur	Roestvrij staal	Type glas	Zwart
Afwerking	Vingervlek vrij	Deur	Met 2 horizontale stroken
Design	Plat	Handgreep	Classici
Afwerking componenten	Roestvrij staal	Kleur handgreep	Rvs look
Materiaal	Roestvrij staal	Logo	In reliëf

Program / Functions

Automatische programma's	52
Aantal verwarmingsfuncties	5
Aantal koelfuncties	5
Automatische reiniging	

Koude functies

 Bewaren	 Flessen koelen	 Invriezen
 Koeling	 Vooraf koelen	

Opwarmfuncties

 Koken op lage temperatuur	 Ontdooien op tijd	 Rijsfunctie
 Gerecht verwarmen	 Ontdooien op gewicht	

Bediening



Display	TFT grafisch met kleuren touch screen	Weergave taal	IT, EN, FR, NL, SP, PT, SWE, RU, DE, DA, NO, PL, FI
Aantal weergaven talen	13	Regeling bediening	Touch control

Opties



Alarm deur open	Ja	Kerntemperatuurmeter	Ja
Timer	Elektronisch	Koelen met kerntemperatuurmeter	Ja
Timer	1	Showroom demo optie	Ja
Kinderbeveiliging	Ja	Geluid	Standaard
Overige opties	Clock settings, Demo mode, Kinderbeveiliging, Taalinstelling, Weergave digitale klok, Tonen	Geheugen	Ja, de 10 laatst gebruikte functies

Technische specificaties

Type compressor	Standaard	Aantal lampen	1
Type koelmiddel	R290	Soort verlichting	Halogeen
Hoeveelheid koelmiddel	130 g	Vermogen lamp	20 W
Geluidsniveau	48 dBA	Automatische inschakeling verlichting bij openen deur	Ja
Temperatuurregeling	Elektronisch	Bovenwarmte - vermogen	250 W
Minimum temperatuur	-35 °C	Deur openen	Standaard opening
Maximum temperatuur	75 °C	Veiligheidsthermostaat	Ja
Materiaal ovenruimte	Roestvrij staal	Automatische uitschakeling verhittingselementen bij openen deur	Ja
Aantal kookniveaus	3	Afmetingen bruikbare interne ovenruimte (hxbxd)	225 x 475 x 360 mm
Type ovenrekken	Metalen zijsteunen		

Meegeleverde accessoires

Ovenrooster met stop	1	Overig	Microvezeldoek
Kerntemperatuurmeter	Ja		

Elektrische aansluiting

Stekker	(F;E) Schuko	Stroom	2,5 A
----------------	--------------	---------------	-------

Spanning 220-240 V
Aansluitwaarde 270 W

Frequentie 50 Hz
Lengte voedingskabel 200 cm

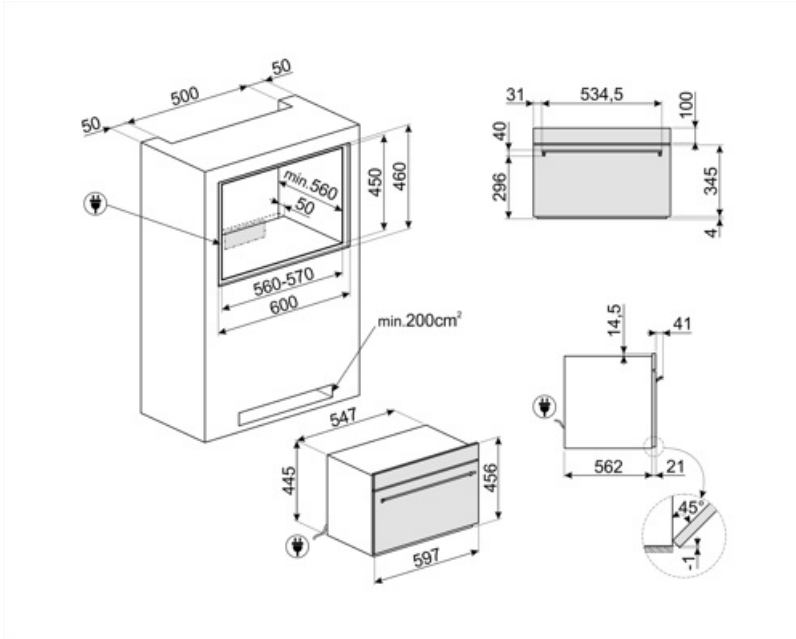



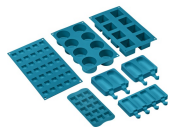













Compatibele Accessoires



SMOLD

Set van 7 siliconen vormpjes voor ijsjes, ijslolly's, pralines, ijsblokjes of om etenswaren te portioneren. Bruikbaar van -60 ° C tot + 230 ° C

Symbols glossary

 <p>Kinderslot: sommige modellen zijn voorzien van een apparaat om het programma / de cyclus te vergrendelen zodat het niet kan per ongeluk veranderd</p>	 <p>Cooling: It allows to quickly cool the food, from the temperature of 80/90°C to 3°C in less than 90 minutes, to prevent bacterial growth, prolong the average life of food and maintain unaltered the quality of food.</p>
 <p>Cold storage: allows to keep the food at the desired temperature between -35°C and +75°C and serve it at its best to enhance flavours and aromas.</p>	 <p>Pre-cooling: allows the cavity to cool to -30 °C before inserting food into the blast chiller, to ensure the best cooling and freezing results. It is recommended to run a 15-minute pre-cooling cycle.</p>
 <p>Bottles cooling: is possible to quickly cool wine and beverage bottles, reducing the need for storage in the refrigerator, with considerable space savings. Cooling of beverages takes place at about 1°C per minute.</p>	 <p>Deep freezing of the food is a very quick process (From 0/90°C temperature to -18°C in less than 270 min) that allows to extend the average life of food (by up to 70% more) and keep the same organoleptic and nutritional characteristics of fresh food, because it avoid the formation of macro-crystals, that ruin the fibers of the food.</p>
 <p>Electric</p>	 <p>Vingerafdrukbestendig roestvrij staal: Vingerafdrukbestendig roestvrij staal zorgt ervoor dat roestvrij staal er zo goed als nieuw uitziet.</p>
 <p>Automatic cleaning: a drying cycle of the cavity to be run with the door open, to eliminate any condensation formed during use.</p>	 <p>Compact appliances with a height of 45 cm - perfect solution to meet the functional requirements of kitchen sets of small height. Available in several types and in different styles.</p>
 <p>Touch control: dankzij de gebruiksvriendelijke Touch control kan het apparaat met één druk op de knop worden geprogrammeerd.</p>	 <p>Ready to eat: This function allows to keep food safely at the refrigerator temperature throughout the day, and heat it just before your return to make it warm, ready to be consumed.</p>
 <p>Low temperature cooking: This function consists in cooking food at a constant temperature, lower than the traditional cooking temperature. Meat results more tender and juicy, maintaining a softness that only this cooking technique allows to obtain.</p>	 <p>Dough leavening/ Yogurt: this function allows you to create the perfect conditions for correct leavening, keeping the mixture at controlled temperatures for the desired time, avoiding sudden changes in humidity levels. This feature also allows the creation of genuine homemade yogurt.</p>
 <p>Thawing by time or by weight: is possible to defrost foods quickly and evenly, without cook the food partially and affect its protein content and with inevitably compromise the quality. The process controls the temperature, preserving the natural moisture and fragrance of the food.</p>	 <p>Thawing by time or by weight: is possible to defrost foods quickly and evenly, without cook the food partially and affect its protein content and with inevitably compromise the quality. The process controls the temperature, preserving the natural moisture and fragrance of the food.</p>

Benefit (TT)

TFT touch display

Full touch colour display for an easy and intuitive user interface

With its intuitive, full-colour interface, it offers an immediate and simple user experience, allowing programmes and functions to be selected quickly. Touch controls provide smooth and precise navigation, while the clear display of temperatures, times and settings ensures optimal control during each step of the process.

Removable temperature probe

High precision and exceptional results with the removable temperature probe, enabling perfect and controlled cooking

Insert the temperature probe to monitor the food's internal temperature for perfect results. The slow cooking function enhances flavors and tenderness while preserving essential nutrients.

Vitality System

The combined use of Smeg blast chiller, Galileo oven and vacuum drawer preserves organoleptic and nutritional qualities of food