

SAB4604NR

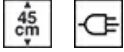

Product Family
Category
Vitality system
Power supply
Heat source
Cooling type

Blast chiller
45cm compact
Yes
Electric
Electric
Fan assisted







Aesthetics

Aesthetic	Dolce Stil Novo	Glass Type	Eclipse
Colour	Black	Door	Full glass
Finishing	Glass	Handle	Dolce Stil Novo
Design	Flat	Handle Colour	Black
Component finish	Copper	Logo	Applied
Material	Glass		





Programs / Functions

No. of warming functions	5
Automatic programmes	52
N. cold functions	5
Automatic cleaning	

Cold functions

 Bottles Cooling	 Cooling	 Deep Freezing
 Pre-cooling	 Preservation	

Warming functions

 Low Temperature Cooking	 Defrost by time	 Proving
 Ready to eat	 Defrost by weight	

Controls

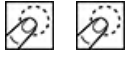

Display / Clock	TFT graphic , colour touch screen	Display languages	IT, EN, FR, NL, SP, PT, SWE, RU, DE, DA, NO, PL, FI
No. of display languages	13	Control setting	Touch control

Options



Door open alarm	Yes	Cooking with probe thermometer	Yes
Minute minder	Electronic	Cooling with probe	Yes
Timer	1	Showroom demo option	Yes
Controls Lock / Child Safety	Yes	Tones	Standard
Other options	Child lock, Clock settings, Demo mode, Language setting, Digital clock display, Tones	Chronology	Yes, the last 10 functions utilised

Technical Features

Compressor type	Standard	No. of lights	1
Refrigerant gas type	R290	Light type	Halogen
Refrigerant Quantity	130 g	Light Power	20 W
Noise level	48 dB(A)	Light when door is opened	Yes
Temperature control	Electronic	Upper heating element - Power	250 W
Minimum Temperature	-35 °C	Door opening type	Standard opening
Maximum temperature	75 °C	Safety Thermostat	Yes
Cavity material	Stainless steel	Heating suspended when door is opened	Yes
No. of shelves	3	Usable cavity space dimensions (HxWxD)	225 x 475 x 360 mm
Shelves type	Metal racks		

Accessories Included

Grid with back stop	1	Temperature probe	Yes
Bottle rack grid	1	Other	Microfiber cloth

Electrical Connection

Plug	(F;E) Schuko	Current	2,5 A
Voltage	220-240 V	Frequency (Hz)	50 Hz

Electrical connection rating (W) 270 W

Power supply cable length 200 cm

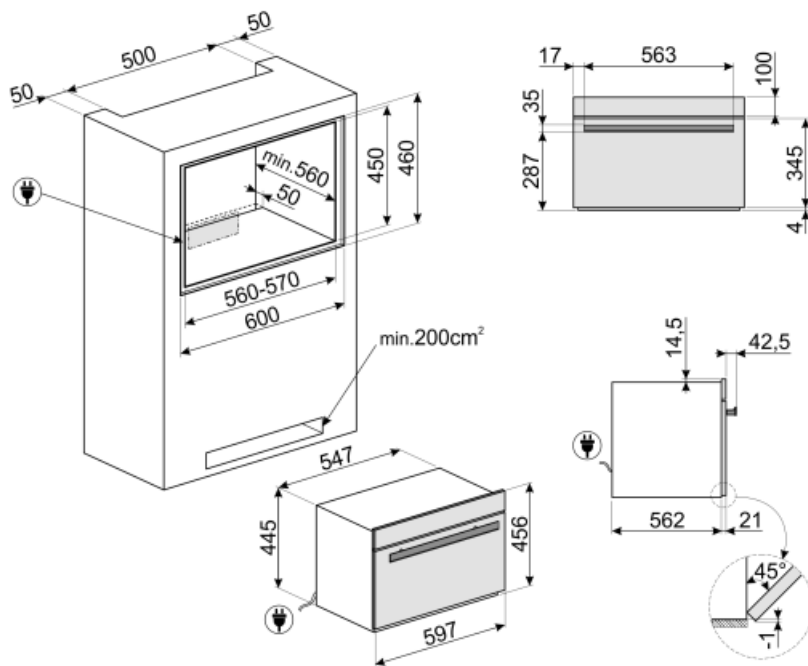



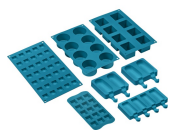











Not included accessories



SMOLD

Set of 7 silicone moulds for ice creams, ice lollies, pralines, ice cubes or to portion food. Usable from -60°C to +230°C

Symbols glossary (TT)

 <p>Child lock: some models are fitted with a device to lock the programme/cycle so it cannot be accidentally changed.</p>	 <p>Cooling: It allows to quickly cool the food, from the temperature of 80/90°C to 3°C in less than 90 minutes, to prevent bacterial growth, prolong the average life of food and maintain unaltered the quality of food.</p>
 <p>Cold storage: allows to keep the food at the desired temperature between -35°C and +75°C and serve it at its best to enhance flavours and aromas.</p>	 <p>Pre-cooling: allows the cavity to cool to -30 °C before inserting food into the blast chiller, to ensure the best cooling and freezing results. It is recommended to run a 15-minute pre-cooling cycle.</p>
 <p>Bottles cooling: is possible to quickly cool wine and beverage bottles, reducing the need for storage in the refrigerator, with considerable space savings. Cooling of beverages takes place at about 1°C per minute.</p>	 <p>Deep freezing of the food is a very quick process (From 0/90°C temperature to -18°C in less than 270 min) that allows to extend the average life of food (by up to 70% more) and keep the same organoleptic and nutritional characteristics of fresh food, because it avoid the formation of macro-crystals, that ruin the fibers of the food.</p>
 <p>Electric</p>	 <p>Automatic cleaning: a drying cycle of the cavity to be run with the door open, to eliminate any condensation formed during use.</p>
 <p>Compact appliances with a height of 45 cm - perfect solution to meet the functional requirements of kitchen sets of small height. Available in several types and in different styles.</p>	 <p>Touch controls: Easy to use touch controls allow the appliance to be programmed at the touch of a button.</p>
 <p>Ready to eat: This function allows to keep food safely at the refrigerator temperature throughout the day, and heat it just before your return to make it warm, ready to be consumed.</p>	 <p>Low temperature cooking: This function consists in cooking food at a constant temperature, lower than the traditional cooking temperature. Meat results more tender and juicy, maintaining a softness that only this cooking technique allows to obtain.</p>
 <p>Dough leavening/ Yogurt: this function allows you to create the perfect conditions for correct leavening, keeping the mixture at controlled temperatures for the desired time, avoiding sudden changes in humidity levels. This feature also allows the creation of genuine homemade yogurt.</p>	 <p>Thawing by time or by weight: is possible to defrost foods quickly and evenly, without cook the food partially and affect its protein content and with inevitably compromise the quality. The process controls the temperature, preserving the natural moisture and fragrance of the food.</p>
 <p>Thawing by time or by weight: is possible to defrost foods quickly and evenly, without cook the food partially and affect its protein content and with inevitably compromise the quality. The process controls the temperature, preserving the natural moisture and fragrance of the food.</p>	