

SAIG3953B



Product Family	Hob
Built-in type	Ultra-low profile
Dimensions	90 cm
Power supply	Mixed
Type	Mixed
EAN code	8017709290207



Aesthetics



Aesthetic	Classic
Serie	New
Colour	Black
Finishing	Glass
Material	Glass
Glass type	Ceramic
Glass edge	Angled edge
Glass on Steel	Yes
Pan stands	Cast iron
Burners	Smeg Contemporary
Burners Material	Brass
Type of control setting	Control knobs
Slider	Yes
Slider	White
Control knob position	Front
No. of controls	1
Controls colour	Steel effect
Logo	Silk screen
Serigraphy colour	Grey

Program / Functions



No. of gas cook zones	1
No. of induction cook zones	4

Time-setting options	Automatic Shutdown
No. of cooking zones with booster	4
No. of Flexible zones	2
Main on/off switch	Yes
Power levels	9
Total no. of cook zones	5

Options



Multizone Option	Yes	Residual time indicator	Yes
Flexible Zone Type	MultiZone	Limited Power	Advanced Eco Logic
Standard cut out	482-486x844-848 mm	Consumption Mode	
Keep warm automatic function	Yes	Limited Power Consumption Mode in W	2400 a 7400 - step 100 W
Grill function	Yes	Showroom Demo Option	Yes
End cooking timer	4	Control Lock / Child Safety	Yes
Pause option	Yes	Bridge option	Yes
Minute minder	1	Quick start	Yes
End of cooking alarm	Yes	Rapid level selection	Yes

Technical Features



Centre-left - Gas - UR - 6.00 kW - Booster 2.50 kW - Double booster 3.00 kW
 Rear-centre - Induction - Multizone - 2.10 kW - Booster 2.50 kW - Double booster 3.00 kW - 18.0x21.0 cm
 Front-centre - Induction - Multizone - 2.10 kW - Booster 2.50 kW - Double booster 3.00 kW - 18.0x21.0 cm
 Rear-right - Induction - Multizone - 2.10 kW - Booster 2.50 kW - Double booster 3.00 kW - 18.0x21.0 cm
 Front-right - Induction - Multizone - 2.10 kW - Booster 2.50 kW - 18.0x21.0 cm

Multizone left - Booster 3.70 kW
 36x21 cm

Multizone right - Booster 3.70 kW - 36x21 cm

Automatic setting according to pan dimension	Yes	Automatic switch off when overheat	Yes
pan detection	Yes, min 9 cm	Automatic switch off when overflow	Yes
Permanent Automatic Pot Detection with indication of the relative control	Yes	Residual heat indicator	Yes
Gas safety valves	Yes	Protection against accidental start up	Yes
Automatic Ignition	Yes		

Accessories Included

Cast iron wok support	1	Other accessories	Linea control knobs kit
------------------------------	---	--------------------------	-------------------------

Electrical Connection

Electrical connection rating (W)	7400 W	Type of electric cable	Single and Double phase
Current	33 A	Frequency (Hz)	50/60 Hz
Voltage (V)	220-240 V	Power supply cable length	120 cm
Voltage 2 (V)	380-415 V	Plug	No

Gas Connection

Gas Type	G20 Natural gas	Other gas connections provided	Cylindrical
Gas connection	Conical	Gas connection rating (W)	6000 W
Other gas nozzles included	G30 GPL Liquid gas		

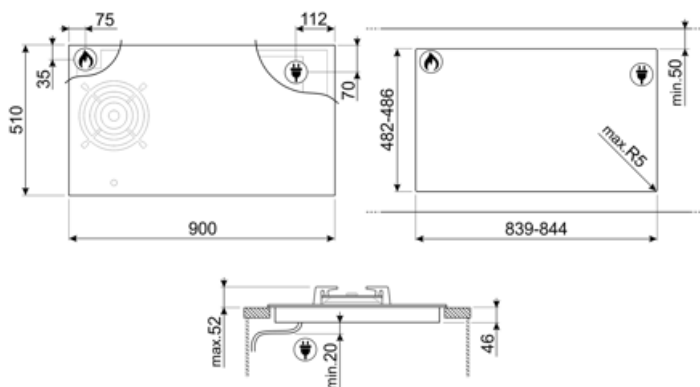

Compatible Accessories

5MPV3MB



TPKPLATE



























Universal plate for induction, gas, ceramic and electric hobs. Non-stick surface ideal for cooking fish, eggs and vegetables. Dimensions: 410 X 240 mm.

GRILLPLATE



Universal griddle for induction, gas, ceramic and electric hobs. Non-stick surface ideal for cooking meat, cheese and vegetables. Dimensions: 410 x 240 mm.

Symbols glossary

 <p>Power booster: option allows the zone to work at full power when very intense cooking is necessary.</p>	 <p>Ultra-low profile: Installation of product with flat edge - height of 1 mm.</p>
 <p>Heavy duty cast iron pan stands: for maximum stability and strength.</p>	 <p>Child lock: some models are fitted with a device to lock the programme/cycle so it cannot be accidentally changed.</p>
 <p>The slider control panel allows you to adjust the power simply by passing your finger across the touch device.</p>	 <p>Reinforced base: A reinforced base, developed exclusively by Smeg, consists of a steel layer fixed to the underside of the glass surface of all gas on glass hobs.</p>
 <p>Keep warm function: Keep warm function keeps the cooked food heated. In this mode the heating zone operates at a minimum capacity for 120 minutes and then turns off automatically.</p>	 <p>Overheat protection: The safety system that automatically turns off the hob in case of overheating of the control unit.</p>
 <p>Multizone: allows several pans to be used at once, large or small, offering freedom of placement and greater flexibility</p>	 <p>Overfill protection: The special overfill protection shuts down the stove in the presence of overflow of liquids.</p>
 <p>PAUSE_72dpi</p>	 <p>Quick selection, with one touch cooking begins at the highest level, then automatically reduces after time. Ideal for dishes that require quick boiling and then continued cooking without constant control (eg beef broth).</p>
 <p>Quick Start function: the chosen temperature is reached faster. The heating element works at maximum power until the right temperature is reached.</p>	 <p>Indication of residual heat: After the glass ceramic hob is switched off the residual heat indicator shows which of the heating zones still remains hot. When the temperature drops below 60 ° C, the indicator goes out.</p>
 <p>Time elapsed: shows how long the cooking zone has been in use.</p>	 <p>Timer: All ceramic hobs have a timer which automatically ends cooking after a preset time.</p>
 <p>TWIN_ZONE_72dpi</p>	 <p>Ultra rapid burners: Powerful ultra rapid burners offer up to 5kw of power.</p>
 <p>Permanent auto pot detection</p>	 <p>Grill function</p>
 <p>Min diameter pot detection of 9 cm.</p>	 <p>Possibility to set the maximum power absorption of the hob.</p>
 <p>Small cut-out for easy installation</p>	 <p>Darkness becomes light</p>
 <p>Knobs control</p>	