

SBC4104B3



Familie
Categorie
Vitality system
Voeding
Warmtebron
Type koeling

Blast chiller
Compact 45 cm
Ja
Elektrisch
Elektrisch
Geventileerd



Design

Esthetiek	Linea	Kleur serigrafie	Grijs
Kleur	Zwart	Deur	Geheel glas
Afwerking	Glanzend	Handgreep	Linea minimal
Design	Plat	Kleur handgreep	Zwart
Materiaal	Glas	Logo	Geëtst
Type glas	Clear1		

Programma's / functies

Aantal verwarmingsfuncties	4
Automatische programma's	10
Aantal koelfuncties	4
Automatische reiniging	
Personaliseerbare recepten	100
Koude functies	

 Bewaren

 Flessen koelen

 Invriezen

 Koeling

 Vooraf koelen

Opwarmfuncties

 Koken op lage temperatuur

 Ontdooien op tijd

 Rijsfunctie

 Gerecht verwarmen

 Ontdooien op gewicht

Bediening



Display

TFT grafisch met kleuren
touch screen

Regeling bediening

Touch control

Opties



Alarm deur open

Ja

Timer

Ja

Timer

2

Kinderbeveiliging

Ja

Kerntemperatuurmeter

Ja

Koelen met
kerntemperatuurmeter

Ja

Showroom demo optie

Ja

Geluid

Polyphonic

Geheugen

Ja, de 10 laatst gebruikte
functies

Touch guide

Sì, a pressione prolungata
su display

Technische specificaties



Type compressor

Standaard

Type koelmiddel

R290

Hoeveelheid koelmiddel

58 g

Klimaatklasse

SN, N, ST, T

Temperatuurregeling

Elektronisch

Minimum temperatuur

-28 °C

Maximum temperatuur

75 °C

Materiaal ovenruimte

Roestvrij staal

Aantal kookniveaus

3

Type ovenrekken

Metalen zijsteunen

Aantal lampen

1

Soort verlichting

Halogeen

Vermogen lamp

1 W

Automatische
inschakeling verlichting
bij openen deur

Ja

Bovenwarmte -
vermogen

250 W

Deur openen

Standaard opening

Veiligheidsthermostaat

Ja

Automatische
uitschakeling
verhittingselementen bij
openen deur

Ja

Bruto inhoud

34 l

Meegeleverde accessoires

Ovenrooster met stop

1

Flessenrek

1

Kerntemperatuurmeter

Ja

Overig

Microvezeldoek

Elektrische aansluiting

Stekker

(F;E) Schuko







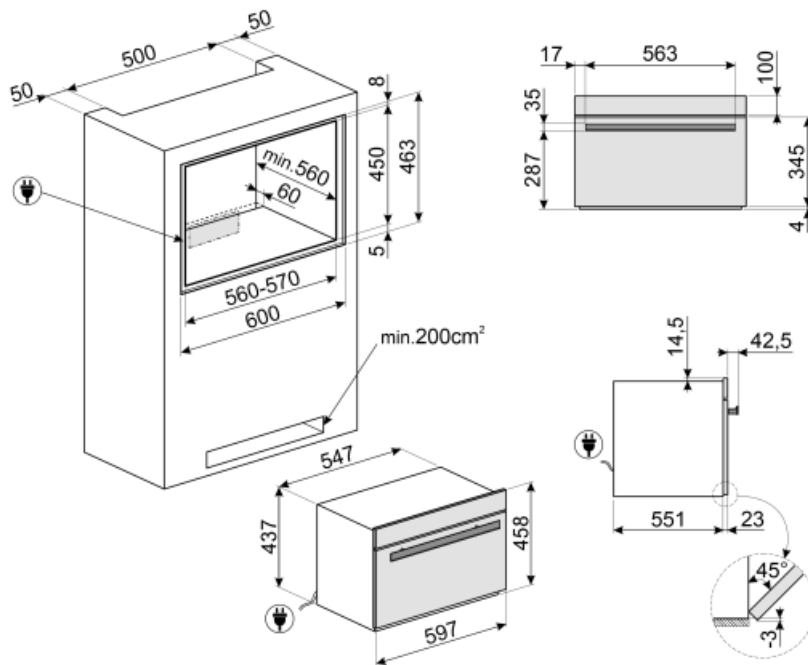









Stroom

2,5 A

Spanning	220-240 V	Frequentie	50 Hz
Aansluitwaarde	270 W	Lengte voedingskabel	200 cm



Symbols glossary (TT)

 <p>Kinderslot: sommige modellen zijn voorzien van een apparaat om het programma / de cyclus te vergrendelen zodat het niet kan per ongeluk veranderd</p>	 <p>Cooling: It allows to quickly cool the food, from the temperature of 80/90°C to 3°C in less than 90 minutes, to prevent bacterial growth, prolong the average life of food and maintain unaltered the quality of food.</p>
 <p>Cold storage: allows to keep the food at the desired temperature between -35°C and +75°C and serve it at its best to enhance flavours and aromas.</p>	 <p>Pre-cooling: allows the cavity to cool to -30 °C before inserting food into the blast chiller, to ensure the best cooling and freezing results. It is recommended to run a 15-minute pre-cooling cycle.</p>
 <p>Bottles cooling: is possible to quickly cool wine and beverage bottles, reducing the need for storage in the refrigerator, with considerable space savings. Cooling of beverages takes place at about 1°C per minute.</p>	 <p>Deep freezing of the food is a very quick process (From 0/90°C temperature to -18°C in less than 270 min) that allows to extend the average life of food (by up to 70% more) and keep the same organoleptic and nutritional characteristics of fresh food, because it avoid the formation of macro-crystals, that ruin the fibers of the food.</p>
 <p>Electric</p>	 <p>Automatic cleaning: a drying cycle of the cavity to be run with the door open, to eliminate any condensation formed during use.</p>
 <p>Compact appliances with a height of 45 cm - perfect solution to meet the functional requirements of kitchen sets of small height. Available in several types and in different styles.</p>	 <p>Touch control: dankzij de gebruiksvriendelijke Touch control kan het apparaat met één druk op de knop worden geprogrammeerd.</p>
 <p>The capacity indicates the amount of usable space in the oven cavity in litres.</p>	 <p>Ready to eat: This function allows to keep food safely at the refrigerator temperature throughout the day, and heat it just before your return to make it warm, ready to be consumed.</p>
 <p>Low temperature cooking: This function consists in cooking food at a constant temperature, lower than the traditional cooking temperature. Meat results more tender and juicy, maintaining a softness that only this cooking technique allows to obtain.</p>	 <p>Dough leavening/ Yogurt: this function allows you to create the perfect conditions for correct leavening, keeping the mixture at controlled temperatures for the desired time, avoiding sudden changes in humidity levels. This feature also allows the creation of genuine homemade yogurt.</p>
 <p>Thawing by time or by weight: is possible to defrost foods quickly and evenly, without cook the food partially and affect its protein content and with inevitably compromise the quality. The process controls the temperature, preserving the natural moisture and fragrance of the food.</p>	 <p>Thawing by time or by weight: is possible to defrost foods quickly and evenly, without cook the food partially and affect its protein content and with inevitably compromise the quality. The process controls the temperature, preserving the natural moisture and fragrance of the food.</p>