

SBC4104B3



Product Family	Refrigerador a jato
Category	45cm compact
Sistema de vitalidade	Yes
Power supply	Electric
Heat source	Electric
Cooling type	Fan assisted



Aesthetics

Aesthetic	Linea	Glass Type	Clear1
Colour	Black	Cor da serigrafia	Serigrafia em cinzento
Acabamento	Brilhante	Door	Full glass
Série	Plano	Handle	Linea minimal
Material	Glass	Handle Colour	Black
Alternative colours available	Stainless steel, Pure Black, Neptune Grey, Nero Lucido	Logotipo	Logotipo serigrafado

Program / Functions

Automatic programmes	8
No. of warming functions	6
Núm. funções frias	5
Limpeza automática	
Customisable recipes	100
Cold functions	

 Arrefecimento



 Pré-resfriamento

 Preservação



 Refrigeração de Garrafas

 Ultracongelamento

Warming functions

	 Proving	 Pronto para comer
Cozimento em baixa temperatura		
Defrosting	Heating	Yoghurt
Multi-step	Yes, up to 2 functions	

Controls

			
Display / Clock	TFT graphic , colour touch screen	Control setting	Touch control

Options

			
Door open alarm	Yes	Arrefecimento com sonda	Yes
Minute minder	Yes	Showroom demo option	Yes
Timer	2	Tones	Polyphonic
Controls Lock / Child Safety	Yes	Chronology	Yes, the last 10 functions utilized
Cooking with probe thermometer	Yes	Touch guide	Sì, a pressione prolungata su display

Technical Features

			
Compressor type	Standard	No. of lights	1
Refrigerant gas type	R290	Light type	Halogen
Refrigerant Quantity	58 g	Light Power	1 W
Climatic class	SN, N, ST, T	Light when door is opened	Yes
Temperature control	Electronic	Upper heating element - Power	250 W
Minimum Temperature	-28 °C	Door opening type	Standard opening
Maximum temperature	75 °C	Soft Close hinges	No
Cavity material	Stainless steel	Safety Thermostat	Yes
No. of shelves	3	Heating suspended when door is opened	Yes
Shelves type	Metal racks	Gross volume	34 l
Double fan	No		

Accessories Included

Grid with back stop	1	Temperature probe	Yes
---------------------	---	-------------------	-----

Bottle rack grid

Yes

Other

Pano de microfibra







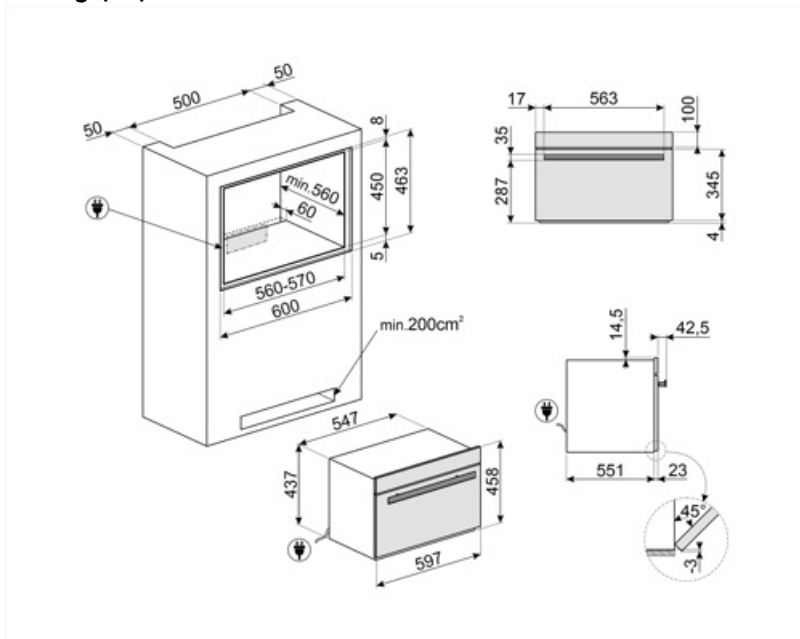







Electrical Connection

Plug (F;E) Schuko
Voltage 220-240 V
Electrical connection rating (W) 270 W

Current 2,5 A
Frequency (Hz) 50 Hz
Comprimento do cabo de alimentação 200 cm



Symbols glossary

	Bloqueio para crianças: alguns modelos estão equipados com um dispositivo para bloquear o programa/ciclo para que não possa ser acidentalmente alterado.		Refrigeração: Permite arrefecer rapidamente os alimentos, da temperatura de 80/90°C a 3°C em menos de 90 minutos, para evitar o crescimento bacteriano, prolongar a vida média dos alimentos e manter inalterada a qualidade dos alimentos.
	Armazenamento a frio: permite manter o alimento na temperatura desejada entre -35°C e +75°C e servi-lo no seu melhor para melhorar os sabores e aromas.		Pré-resfriamento: permite que a cavidade resfrie a -30°C inserindo os alimentos no abatedor de temperatura, para garantir os melhores resultados de resfriamento e congelamento. Recomenda-se executar um ciclo de pré-arrefecimento de 15 minutos.
	Resfriamento de garrafas: é possível resfriar rapidamente garrafas de vinho e bebidas, reduzindo a necessidade de armazenamento na geladeira, com considerável economia de espaço. O resfriamento das bebidas ocorre a cerca de 1°C por minuto.		O congelamento profundo dos alimentos é um processo muito rápido (da temperatura de 0/90°C até -18°C em menos de 270 min) que permite prolongar a vida média dos alimentos (em até 70% a mais) e manter as mesmas características organolépticas e nutricionais dos alimentos frescos, pois evita a formação de macrocristais, que arruínam as fibras dos alimentos.
	Elétrico		Limpeza automática: um ciclo de secagem da cavidade a ser executado com a porta aberta, para eliminar qualquer condensação formada durante o uso.
	Aparelhos compactos com uma altura de 45 cm - solução perfeita para atender aos requisitos funcionais de conjuntos de cozinha de pequena altura. Disponível em vários tipos e em diferentes estilos.		Controles táteis: O controles táteis, fáceis de usar, permitem que o aparelho seja programado com o toque de um botão.
	A capacidade indica a quantidade de espaço útil no compartimento do forno em litros.		Pronto para comer: Esta função permite manter os alimentos em segurança à temperatura da geladeira durante todo o dia, e aquecê-los pouco antes do seu retorno para torná-los quentes, prontos para serem consumidos.
	Baixa temperatura de cozimento. Esta função consiste em cozinhar alimentos a uma temperatura constante, inferior à temperatura de cozimento tradicional. A carne resulta mais macia e suculenta, mantendo uma suavidade que só esta técnica de cozedura permite obter.		Massa de fermentação/logurte: esta função permite criar as condições perfeitas para a fermentação correta, mantendo a mistura em temperaturas controladas durante o tempo desejado, evitando mudanças repentinas nos níveis de umidade. Este recurso também permite a criação de iogurte caseiro genuíno.

Benefit (TT)

TFT touch display

Full touch colour display for an easy and intuitive user interface

With its intuitive, full-colour interface, it offers an immediate and simple user experience, allowing programmes and functions to be selected quickly. Touch controls provide smooth and precise navigation, while the clear display of temperatures, times and settings ensures optimal control during each step of the process.

Removable temperature probe

High precision and exceptional results with the removable temperature probe, enabling perfect and controlled cooking

Insert the temperature probe to monitor the food's internal temperature for perfect results. The slow cooking function enhances flavors and tenderness while preserving essential nutrients.

Touch Guide

Enhanced ease of use, functionality and assistance thanks to the touch guide for a better display navigation

The Touch Guide provides pop-up explanations and tips when you press an icon.

Vitality System

The combined use of Smeg blast chiller, Galileo oven and vacuum drawer preserves organoleptic and nutritional qualities of food

Oven-interchangeable multifunctional grids

Maximum flexibility thanks to the oven-interchangeable grids, supporting containers and food or, when rotated, serving as a bottle holder.