

SBC4104G

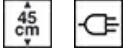

Product Family	Blast chiller
Category	45cm compact
Vitality system	Yes
Power supply	Electric
Heat source	Electric
Cooling type	Fan assisted





Aesthetics

Aesthetic	Linea	Glass Type	Clear1
Colour	Neptune Grey	Serigraphy colour	Black
Finishing	Matt	Door	Full glass
Design	Flat	Handle	Linea minimal
Material	Glass	Handle Colour	Satin metal and black
Alternative colours available	Stainless steel, Pure Black, Neptune Grey, Nero Lucido	Logo	Silk screen



Programs / Functions

Automatic programmes	8
No. of warming functions	6
N. cold functions	5
Automatic cleaning	
Customisable recipes	100
Cold functions	

 Bottles Cooling	 Cooling	 Deep Freezing
----------------------------------------------------------------------------------------------------	---------------------------------------------------------------------------------------------	-----------------------------------------------------------------------------------------------------

 Pre-cooling	 Preservation
------------------------------------------------------------------------------------------------	--------------------------------------------------------------------------------------------------

Warming functions

 Low Temperature Cooking	 Proving	 Ready to eat
------------------------------------------------------------------------------------------------------------	---------------------------------------------------------------------------------------------	----------------------------------------------------------------------------------------------------

Defrosting	Heating	Yoghurt
------------	---------	---------

Multi-step

Yes, up to 2 functions

Controls



Display / Clock

TFT graphic , colour touch screen

Control setting

Touch control

Options



Door open alarm

Yes

Cooling with probe

Yes

Minute minder

Yes

Showroom demo option

Yes

Timer

2

Tones

Polyphonic

Controls Lock / Child Safety

Yes

Chronology

Yes, the last 10 functions utilized

Cooking with probe thermometer

Yes

Touch guide

Sì, a pressione prolungata su display

Technical Features



Compressor type

Standard

No. of lights

1

Refrigerant gas type

R290

Light type

Halogen

Refrigerant Quantity

58 g

Light Power

1 W

Climatic class

SN, N, ST, T

Light when door is opened

Yes

Temperature control

Electronic

Upper heating element - Power

250 W

Minimum Temperature

-28 °C

Maximum temperature

75 °C

Door opening type

Standard opening

Cavity material

Stainless steel

Safety Thermostat

Yes

No. of shelves

3

Heating suspended when door is opened

Yes

Shelves type

Metal racks

Gross volume

34 l

Accessories Included

Grid with back stop

1

Temperature probe

Yes

Bottle rack grid

Yes

Other

Microfiber cloth

Electrical Connection

Plug

(F;E) Schuko

Current

2.5 A

Voltage

220-240 V

Frequency (Hz)

50 Hz

Electrical connection rating (W)







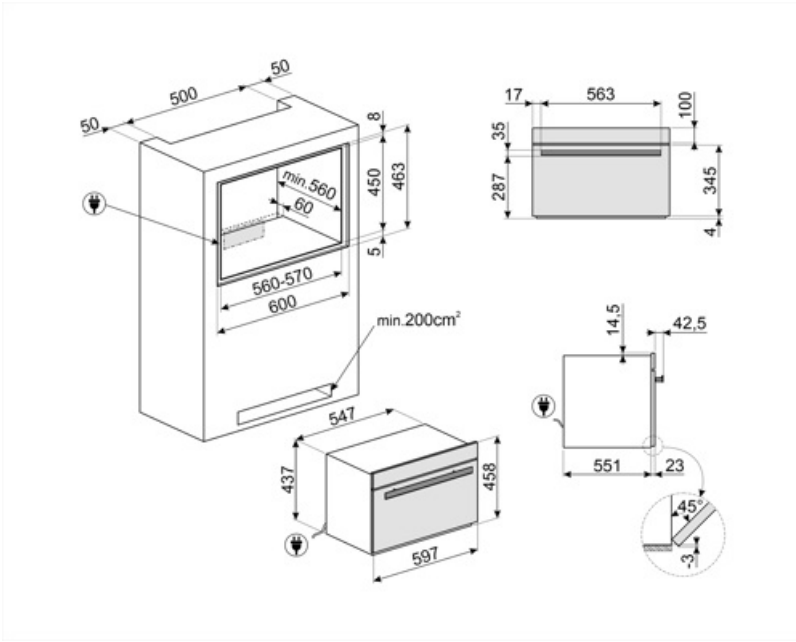







270 W

Power supply cable length

200 cm



Symbols glossary

 <p>Child lock: some models are fitted with a device to lock the programme/cycle so it cannot be accidentally changed.</p>	 <p>Cooling: It allows to quickly cool the food, from the temperature of 80/90°C to 3°C in less than 90 minutes, to prevent bacterial growth, prolong the average life of food and maintain unaltered the quality of food.</p>
 <p>Cold storage: allows to keep the food at the desired temperature between -35°C and +75°C and serve it at its best to enhance flavours and aromas.</p>	 <p>Pre-cooling: allows the cavity to cool to -30 °C before inserting food into the blast chiller, to ensure the best cooling and freezing results. It is recommended to run a 15-minute pre-cooling cycle.</p>
 <p>Bottles cooling: is possible to quickly cool wine and beverage bottles, reducing the need for storage in the refrigerator, with considerable space savings. Cooling of beverages takes place at about 1°C per minute.</p>	 <p>Deep freezing of the food is a very quick process (From 0/90°C temperature to -18°C in less than 270 min) that allows to extend the average life of food (by up to 70% more) and keep the same organoleptic and nutritional characteristics of fresh food, because it avoid the formation of macro-crystals, that ruin the fibers of the food.</p>
 <p>Electric</p>	 <p>Automatic cleaning: a drying cycle of the cavity to be run with the door open, to eliminate any condensation formed during use.</p>
 <p>Compact appliances with a height of 45 cm - perfect solution to meet the functional requirements of kitchen sets of small height. Available in several types and in different styles.</p>	 <p>Touch controls: Easy to use touch controls allow the appliance to be programmed at the touch of a button.</p>
 <p>The capacity indicates the amount of usable space in the oven cavity in litres.</p>	 <p>Ready to eat: This function allows to keep food safely at the refrigerator temperature throughout the day, and heat it just before your return to make it warm, ready to be consumed.</p>
 <p>Low temperature cooking: This function consists in cooking food at a constant temperature, lower than the traditional cooking temperature. Meat results more tender and juicy, maintaining a softness that only this cooking technique allows to obtain.</p>	 <p>Dough leavening/ Yogurt: this function allows you to create the perfect conditions for correct leavening, keeping the mixture at controlled temperatures for the desired time, avoiding sudden changes in humidity levels. This feature also allows the creation of genuine homemade yogurt.</p>

Benefit (TT)

TFT touch display

Full touch colour display for an easy and intuitive user interface

With its intuitive, full-colour interface, it offers an immediate and simple user experience, allowing programmes and functions to be selected quickly. Touch controls provide smooth and precise navigation, while the clear display of temperatures, times and settings ensures optimal control during each step of the process.

Removable temperature probe

High precision and exceptional results with the removable temperature probe, enabling perfect and controlled cooking

Insert the temperature probe to monitor the food's internal temperature for perfect results. The slow cooking function enhances flavors and tenderness while preserving essential nutrients.

Touch Guide

Enhanced ease of use, functionality and assistance thanks to the touch guide for a better display navigation

The Touch Guide provides pop-up explanations and tips when you press an icon.

Vitality System

The combined use of Smeg blast chiller, Galileo oven and vacuum drawer preserves organoleptic and nutritional qualities of food

Oven-interchangeable multifunctional grids

Maximum flexibility thanks to the oven-interchangeable grids, supporting containers and food or, when rotated, serving as a bottle holder.