

SBC4304X

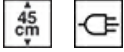

Product Family	Blast chiller
Category	45 cm compact
Vitality system	Yes
Power supply	Electric
Heat source	Electric
Cooling type	Fan assisted



Aesthetics

Aesthetic	Classica	Alternative colours available	Stainless steel, Pure Black, Neptune Grey, Nero Lucido
Colour	Stainless steel		
Finishing	Fingerproof	Glass Type	Eclipse
Design	Flat	Door	With 2 horizontal strips
Component finish	Stainless steel	Handle	Classic
Material	Stainless steel	Handle Colour	Steel effect
Type of steel	Brushed	Logo	Embossed

Program / Functions

Automatic programmes	8
No. of warming functions	6
N. cold functions	5
Automatic cleaning	
Customisable recipes	100
Cold functions	

Bottles Cooling	Cooling	Deep Freezing
-----------------	---------	---------------

Pre-cooling	Preservation
-------------	--------------

Warming functions

Low Temperature Cooking	Proving	Ready to eat
-------------------------	---------	--------------

Defrosting	Heating	Yoghurt
------------	---------	---------

Multi-step

Yes, up to 2 functions

Controls



Display / Clock

TFT graphic , colour touch screen

Control setting

Touch control

Options



Door open alarm Yes

Minute minder Yes

Timer 2

Controls Lock / Child Safety Yes

Cooking with probe thermometer Yes

Cooling with probe Yes

Showroom demo option Yes

Tones Polyphonic

Chronology Yes, the last 10 functions utilized

Touch guide Sì, a pressione prolungata su display

Technical Features



Compressor type Standard

Refrigerant gas type R290

Refrigerant Quantity 58 g

Climatic class SN, N, ST, T

Temperature control Electronic

Minimum Temperature -28 °C

Maximum temperature 75 °C

Cavity material Stainless steel

No. of shelves 3

Shelves type Metal racks

No. of lights 1

Light type Halogen

Light Power 1 W

Light when door is opened Yes

Upper heating element - Power 250 W

Door opening type Standard opening

Safety Thermostat Yes

Heating suspended when door is opened Yes

Gross volume 34 l

Accessories included

Grid with back stop 1

Bottle rack grid Yes

Temperature probe Yes

Other Microfiber cloth

Electrical Connection

Voltage 220-240 V

Plug (F;E) Schuko

Electrical connection rating (W) 270 W







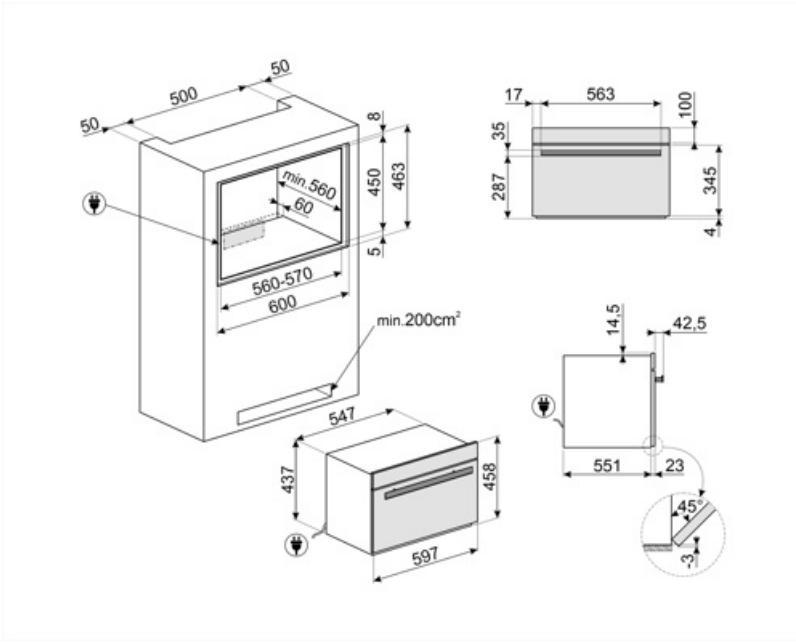







Current 2,5 A

Frequency (Hz) 50 Hz

Power supply cable length 200 cm



Symbols glossary

 <p>Child lock: some models are fitted with a device to lock the programme/cycle so it cannot be accidentally changed.</p>	 <p>Cooling: It allows to quickly cool the food, from the temperature of 80/90°C to 3°C in less than 90 minutes, to prevent bacterial growth, prolong the average life of food and maintain unaltered the quality of food.</p>
 <p>Cold storage: allows to keep the food at the desired temperature between -35°C and +75°C and serve it at its best to enhance flavours and aromas.</p>	 <p>Pre-cooling: allows the cavity to cool to -30 °C before inserting food into the blast chiller, to ensure the best cooling and freezing results. It is recommended to run a 15-minute pre-cooling cycle.</p>
 <p>Bottles cooling: is possible to quickly cool wine and beverage bottles, reducing the need for storage in the refrigerator, with considerable space savings. Cooling of beverages takes place at about 1°C per minute.</p>	 <p>Deep freezing of the food is a very quick process (From 0/90°C temperature to -18°C in less than 270 min) that allows to extend the average life of food (by up to 70% more) and keep the same organoleptic and nutritional characteristics of fresh food, because it avoid the formation of macro-crystals, that ruin the fibers of the food.</p>
 <p>Electric</p>	 <p>Fingerprint proof stainless steel: Fingerprint proof stainless steel keeps stainless steel looking as good as new.</p>
 <p>Automatic cleaning: a drying cycle of the cavity to be run with the door open, to eliminate any condensation formed during use.</p>	 <p>Compact appliances with a height of 45 cm - perfect solution to meet the functional requirements of kitchen sets of small height. Available in several types and in different styles.</p>
 <p>Touch controls: Easy to use touch controls allow the appliance to be programmed at the touch of a button.</p>	 <p>The capacity indicates the amount of usable space in the oven cavity in litres.</p>
 <p>Ready to eat: This function allows to keep food safely at the refrigerator temperature throughout the day, and heat it just before your return to make it warm, ready to be consumed.</p>	 <p>Low temperature cooking: This function consists in cooking food at a constant temperature, lower than the traditional cooking temperature. Meat results more tender and juicy, maintaining a softness that only this cooking technique allows to obtain.</p>
 <p>Dough leavening/ Yogurt: this function allows you to create the perfect conditions for correct leavening, keeping the mixture at controlled temperatures for the desired time, avoiding sudden changes in humidity levels. This feature also allows the creation of genuine homemade yogurt.</p>	