

## SBS63XDE



Product familie	Koelkast
Installatie	Vrijstaand
Categorie	Side-by-side koel-vriescombinatie
Referentie breedte	Meer dan 80 cm
Referentie hoogte	160 - 200 cm
No Frost systeem	Ja
Type koelen	No Frost
Ontdooien	Automatisch ontdooien
Type scharnier	Standaard
EAN-code	8017709337636



## Design



Design	Universeel	Materiaal zijwanden	Staal
Kleur	Inox Look	Kleur zijkanten	Zilver
Design	Plat	Logo	Geassembleerd
Materiaal deur	Inox look	Kleur profielen laden	Zilver
Handgreep	Extern	Kleur profiel glazen leggers	Zilver
Type handgreep	Vast	Display	LED
Kleur handgreep	Inox	Positie display	Esterno (su porta)
Kleur logo	Chroom		

## Uitrusting koelkast



Number of compartments	4	Afdekplaat groentenlade	Ja
Compartment types	Low temperature compartment, Fruit and vegetable compartment	Type afdekplaat groente-/fruitlade	Glas
Aantal verstelbare leggers	3	Convertible temperature drawer	No
Aantal groente-/fruitlades	2	Low temperature compartment	Ja
Shelves material	Glas	Binnenverlichting koelkast	Ja
Type afdekplaat groente-/fruitlade	Standaard	Type binnenverlichting koelkast	LED

## Binnendeur koelkast

Aantal verstelbare  
binnendeurcompartimenten 4

Aantal flessenhouders 1

## Overige features koelkast



Humidity Control No  
 Accessoires Eierhouder  
 Natural Plus Blue Light Ja  
 MultiFlow Ja

Ventilator Ja  
 Active Ion technology Ja  
 Anti bacteriële  
geurfilter Ja

## Uitrusting vriezer

Aantal lades 2  
 Aantal legplanken 4  
 Binnenverlichting  
vriezer Ja

Type verlichting vriezer LED  
 Type leggers Glas

## Binnendeur vriezer

Aantal  
binnendeurcompartimenten 4

## Overige features vriezer



Ice maker Manueel ontdooien

Snel-vriescompartiment Ja

## Overige technische eigenschappen



Display functies  
 Snel-vriestoets  
 Alarm open deur  
 Temperature Alarm  
 Type temperatuurcontrole  
 Aantal compressoren  
 Type koelgas  
 Schuimmiddel

Vakantiefunctie, Snel-vriesfunctie, Snel-koelfunctie, ECO,  
Kinderbeveiliging, Temperatuuralarm  
 Ja  
 Ja  
 Ja  
 Elektronisch  
 1  
 R600a  
 Cyclopentaan

## Prestaties/Energie label - Reg. 2019



<b>Annual energy consumption</b>	327 kWh/jaar	<b>Geluidsniveau</b>	38 dB(A) re 1 pW
<b>Energie-efficiëntieklasse</b>	E	<b>Conserveringsduur zonder stroom</b>	9 h
<b>Emissieklasse voor akoestisch luchtgeluid</b>	C	<b>4 star - Freezing capacity</b>	13.0 kg/24h
<b>Totaal netto volume</b>	580 l	<b>Klimaatklasse</b>	SN, N, ST, T
<b>Netto inhoud vriesgedeelte</b>	212 l	<b>EEL</b>	99 %
<b>Netto inhoud koelgedeeltes</b>	368 l		

## Elektrische aansluiting







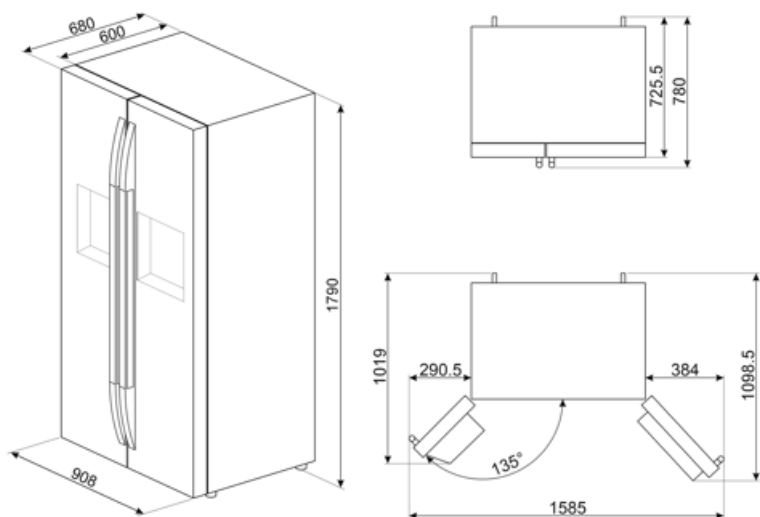





<b>Nominale aansluitwaarde</b>	150 W	<b>Frequentie (Hz)</b>	50 Hz
<b>Stroom (A)</b>	0.85 A	<b>Lengte stroomkabel</b>	215 cm
<b>Spanning (V)</b>	220-240 V	<b>Stekker</b>	(F;E) Schuko

## Logistieke informatie

<b>Breedte product (mm)</b>	910 mm	<b>Maximum hoogte</b>	1790 mm
<b>Diepte zonder handvat en spacer</b>	750 mm		



## Symbols glossary

	Smeg Active Ion system improves the quality of the air inside the cell. Thanks to the generation of negatively charged ions released inside the fridge Active Ion system neutralizes unpleasant dust.		The automatic defrost system works by automatically defrosting at regular intervals eliminating the need to defrost altogether.
	Sommige modellen zijn voorzien van een functie om het programma/de cyclus te blokkeren zodat het niet per ongeluk kan aangepast worden.		LED display: to show programmes, functions and options selected and the time to the end of the cycle.
	Economical mode: Analyzes fridge functioning during the activation and optimizes the operating cycle in order to reduce power consumption.		Geventileerd: een geforceerde verdeling van koude lucht in het koelkast compartiment, die een gelijke temperatuurverdeling verzekert in de koelkast.
	Fast freezing: The fast freezing function brings the temperature of the compartment down when activated a few hours prior to usage.		Power saving mode: The power saving mode allows you to disable the refrigerator and keep the freezer working.
	LED interior lighting: is a more energy efficient and long lasting way of illuminating the interior of the appliance.		Multiflow Cooling System: the Multiflow ventilation system allows an even distribution of cool air around the fridge cabinet.
	Natural Plus Blue Light: Dit unieke Natural Plus Blue Light-systeem verlengt de bewaartijd van groenten en fruit		Energie-efficiëntieklasse