

## SBS63XDF



Product familie	Koelkast
Installatie	Vrijstaand
Categorie	Side-by-side koel-vriescombinatie
Reference width	Meer dan 80 cm
No Frost systeem	Totaal No-Frost
Type koelen	Geventileerde koelkast, No Frost vriezer
Ontdooien	Automatisch ontdooien
Type scharnier	Standaard
EAN-code	8017709293246



## Design



Design	Universeel	Materiaal zijwanden	Staal
Kleur	Inox-look	Kleur zijkanten	Zilver
Design	Plat	Logo	Geassembleerd
Materiaal deur	Inox look	Kleur profielen laden	Zilver
Handgreep	Extern	Kleur profiel glazen leggers	Zilver
Type handgreep	Vast	Display	LED
Kleur handgreep	Inox	Positie display	Esterno (su porta)
Kleur logo	Chroom		

## Uitrusting koelkast



Aantal verstelbare leggers	3	Type afdekplaat groente-/fruitlade	Glas
Aantal groente-/fruitlades	2	Life Plus zone 0°C	Ja
Type verstelbare leggers	Glas	Binnenverlichting koelkast	Ja
Type afdekplaat groente-/fruitlade	Standaard	Type binnenverlichting koelkast	LED
Afdekplaat groentenlade	Ja		

## Binnendeur koelkast

Aantal verstelbare  
binnendeurcompartimenten 4

Aantal flessenhouders 1

## Overige features koelkast



Accessoires Eierhouder  
Natural Plus Blue Light Ja  
MultiFlow Ja

Ventilator Ja  
Active Ion technology Ja  
Anti bacteriële  
geurfilter Ja

## Uitrusting vriezer

Aantal lades 2  
Aantal legplanken 4  
Binnenverlichting  
vriezer Ja

Type verlichting vriezer LED  
Type leggers Glas

## Binnendeur vriezer

Aantal  
binnendeurcompartimenten 4

## Overige features vriezer



Ijsmaker (manueel) Ja  
Ice maker Manueel ontdooien

Snel-vriescompartiment Ja

## Overige technische eigenschappen



Display functies

Vakantiefunctie, Snel-vriesfunctie, Snel-koelfunctie, ECO,  
Kinderbeveiliging, Temperatuuralarm

Snel-vriestoets

Ja

Alarm open deur

Ja

Temperature Alarm

Ja

Type temperatuurcontrole

Elektronisch

Aantal compressoren

1

Type koelgas

R600a

Hoeveelheid koelmiddel

62 g

Schuimmiddel

Cyclopentaan

## Prestaties/Energie label - Reg. 2019









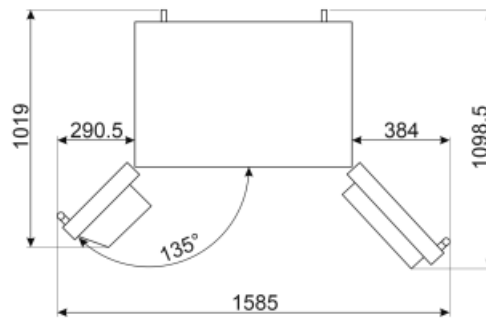
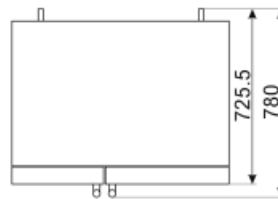
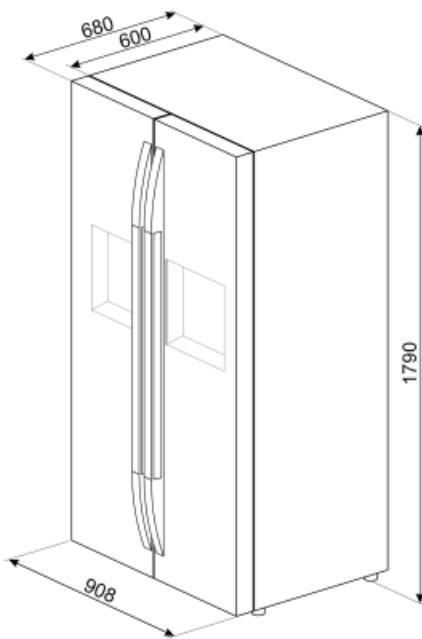









<b>Annual energy consumption</b>	405 KWh/jaar	<b>Geluidsniveau</b>	38 dB(A) re 1pW
<b>Energie-efficiëntieklasse</b>	F	<b>Conserveringsduur zonder stroom</b>	9 h
<b>Emissieklasse voor akoestisch luchtgeluid</b>	C	<b>4 star - Freezing capacity</b>	13.0 Kg/24h
<b>Totaal netto volume</b>	580 l	<b>Klimaatklasse</b>	SN, N, ST, T
<b>Netto inhoud vriesgedeelte</b>	212 l	<b>EEl</b>	123 %
<b>Netto inhoud koelgedeeltes</b>	368 l		

## Elektrische aansluiting

<b>Stekker</b>	(F;E) Schuko	<b>Spanning (V)</b>	220-240 V
<b>Nominale aansluitwaarde</b>	150 W	<b>Frequentie (Hz)</b>	50 Hz
<b>Stroom (A)</b>	0.85 A	<b>Lengte stroomkabel</b>	215 cm



## Symbols glossary (TT)

 <p>4 stars freezing compartment for better food preservation.</p>	 <p>Smeg Active Ion system improves the quality of the air inside the cell. Thanks to the generation of negatively charged ions released inside the fridge Active Ion system neutralizes unpleasant dust.</p>
 <p>The automatic defrost system works by automatically defrosting at regular intervals eliminating the need to defrost altogether.</p>	 <p>Sommige modellen zijn voorzien van een functie om het programma/de cyclus te blokkeren zodat het niet per ongeluk kan aangepast worden.</p>
 <p>LED display: to show programmes, functions and options selected and the time to the end of the cycle.</p>	 <p>Economical mode: Analyzes fridge functioning during the activation and optimizes the operating cycle in order to reduce power consumption.</p>
 <p>A+: Energy efficiency class A+ helps to save up to 10% energy compared to class A. Maximum performance with minimum consumption is guaranteed.</p>	 <p>Geventileerd: een geforceerde verdeling van koude lucht in het koelkast compartiment, die een gelijke temperatuurverdeling verzekert in de koelkast.</p>
 <p>Fast freezing: The fast freezing function brings the temperature of the compartment down when activated a few hours prior to usage.</p>	 <p>Power saving mode: The power saving mode allows you to disable the refrigerator and keep the freezer working.</p>
 <p>LED interior lighting: is a more energy efficient and long lasting way of illuminating the interior of the appliance.</p>	 <p>Life Plus 0°C: The temperature in the Lifeplus compartments is kept at 0°C, which preserves fresh meat and fish longer.</p>
 <p>Air plus: keeps food fresher for longer.</p>	 <p>Natural Plus Blue Light: Dit unieke Natural Plus Blue Light-systeem verlengt de bewaartijd van groenten en fruit</p>
 <p>No Frost: The No Frost and Frost free systems prevent ice from forming so that no defrosting is required.</p>	 <p>Energie-efficiëntieklasse</p>