

SBS63XNSG



Product Family	Refrigerator
Installation	Free standing
Category	Side-by-side
Reference width	Higher than 80 cm
Reference height	160 - 200 cm
Sistema Total No - Frost	Yes
Cooling type	Total No Frost
Defrost	Automatic
Hinge type	Standard
EAN code	8017709329006



Aesthetics



Aesthetic	Universale	Side material	Steel
Colour	Inox Look	Side colour	Silver
Design	Flat	Logo	Applied
Material	Steel Effect	Drawers profile color	Silver
Handle	External	Color of glass shelf profile	Silver
Handle type	Fixed	Display	LED
Handle colour	Stainless steel	Display position	Esterno (su porta)
Logo colour	Chrome		

Refrigerator compartment features



Number of compartments	4	Crisper Cover	Yes
Compartment types	Low temperature compartment, Fruit and vegetable compartment	Type of crisper/vegetable drawers cover	Glass
No. of adjustable shelves	3	Low temperature compartment	Yes
Number of fruit and vegetables drawers	2	Internal light in fridge	Yes
Shelves material	Glass	Type of internal light (fridge)	LED
Type of crisper/vegetable drawers cover	Standard		

Refrigerator Inner Door

Number of adjustable door shelves	4	No. of bottle shelves	1
-----------------------------------	---	-----------------------	---

Other Refrigerator features



Accessories	Egg tray	Fan	Yes
Natural Plus Blu Light	Yes	Antibacterial odour filter	Yes
MultiFlow	Yes		

Freezer compartment features

Number of drawers	2	Type of internal light (freezer)	LED
No. of shelves	4	Type of shelves	Glass
Internal light in freezer	Yes		

Freezer Inner Door

No. of adjustable door shelves	4
--------------------------------	---

Other Freezer features



Ice maker	Manual	Fast freezing compartment	Yes
-----------	--------	---------------------------	-----

Other technical features

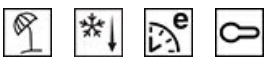

Functions display	Holiday, Fast freezing, Fast cooling, ECO, Control lock, Temperature alarm
Fast freezing button	Yes
Door open alarm	Yes
Temperature Alarm	Yes
Type of temperature control	Electronic
No. of compressors	1
Refrigerant gas type	R600a
Foam agent	Cyclopentane

Performance / Energy Label - Reg. 2019

Total net volume	580 l	Sum of the volumes of the chill compartment(s) and the unfrozen compartment(s)	368 l
Sum of the volumes of the frozen compartment(s)	212 l		

Electrical Connection







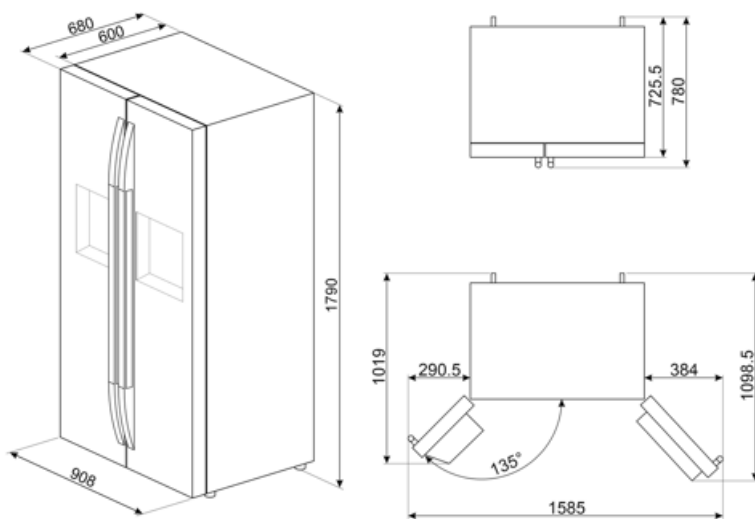



Electrical connection rating	150 W	Frequency (Hz)	50 Hz
Current	0,85 A	Power supply cable length	215 cm
Voltage (V)	230 V	Plug	(G) UK e Singapore

Logistic Information

Product depth with handle	735 mm
---------------------------	--------



Symbols glossary

	The automatic defrost system works by automatically defrosting at regular intervals eliminating the need to defrost altogether.		Child lock: some models are fitted with a device to lock the programme/cycle so it cannot be accidentally changed.
	LED display: to show programmes, functions and options selected and the time to the end of the cycle.		Economical mode: Analyzes fridge functioning during the activation and optimizes the operating cycle in order to reduce power consumption.
	Ventilated: Forced distribution of cold air in the refrigerator compartment, which allows even temperature distribution within the fridge.		Fast freezing: The fast freezing function brings the temperature of the compartment down when activated a few hours prior to usage.
	Power saving mode: The power saving mode allows you to disable the refrigerator and keep the freezer working.		LED interior lighting: is a more energy efficient and long lasting way of illuminating the interior of the appliance.
	Multiflow Cooling System: the Multiflow ventilation system allows an even distribution of cool air around the fridge cabinet.		Natural Plus Blu Light: This unique Natural Plus Blu Light system works with nature to increase the storage time of fruit and vegetables.