

# SCV115A



Product Family	Wine Cooler
Installation	Free standing
Defrost	Automatic
Cooling type	Fan assisted
Hinge type	Standard
Hinge position	Right



## Wine cooler compartment features



Number of fixed shelves	1
Number of removable shelves	5
Number of removable and folding shelves	1
Shelves material	Wood
Adjustable shelves	Yes
Type of internal light	LED
Air filter	Activated charcoal filter

## Programs / Functions



Control setting	Control buttons	Control lock	Yes
Controls	External, in the lower socket	Temperature Alarm	Yes
Display	7 digits LED	Door open alarm	Yes

## Technical Features

Adjustable temperature zones	2	Refrigerant gas type	R600a
Temperature range	5-22 °C	Refrigerant Quantity (gr)	80 g
Type of temperature control	Electronic	Foam agent	Cyclopentane
Anti-UV door glass	Yes	Metal panel on the back of the fridge	Metal
		Adjustable feet	2 Front

<b>Integrated heating element</b>	Yes	<b>Door opening type</b>	With handle
<b>Number of compressors</b>	1		
<b>Compressor type</b>	Low vibration compressor		

## Performance / Energy Label NEW





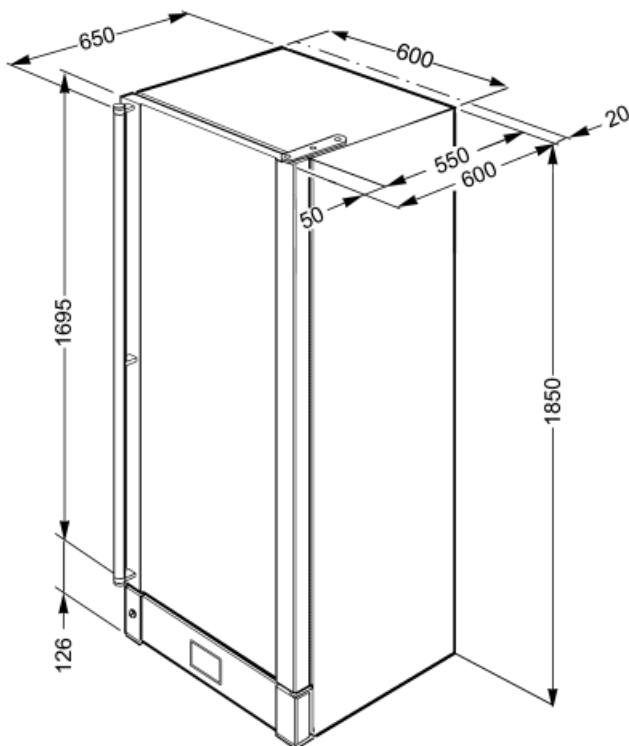

			
<b>Max Capacity (bottles 0,75lt)</b>	198	<b>Sum of the volumes of the chill compartment(s) and the unfrozen compartment(s)</b>	368 l
<b>Annual energy consumption</b>	181 kWh/year	<b>Climatic class</b>	SN, N, ST
<b>Energy efficiency class</b>	G	<b>EEL</b>	179 %
<b>Airborne acoustical noise emission class</b>	D	<b>Noise level</b>	42 dB(A) re 1 pW
<b>Total volume</b>	368 l		

## Electrical Connection

<b>Plug</b>	(F;E) Schuko	<b>Voltage (V)</b>	220-240 V
<b>Nominal power</b>	200 W	<b>Frequency (Hz)</b>	50 Hz
<b>Current</b>	1 A		



## Symbols glossary

-  The automatic defrost system works by automatically defrosting at regular intervals eliminating the need to defrost altogether.
-  Energy efficiency class G
-  Ventilated: Forced distribution of cold air in the refrigerator compartment, which allows even temperature distribution within the fridge.
-  LED interior lighting: is a more energy efficient and long lasting way of illuminating the interior of the appliance.
-  A: Product drying performance, measured from A+++ to D / G depending on the product family
-  LED display: to show programmes, functions and options selected and the time to the end of the cycle.
-  Fingerprint proof stainless steel: Fingerprint proof stainless steel keeps stainless steel looking as good as new.