

SCV115A



| | |
|----------------|---------------|
| Family | Wine Cooler |
| Installation | Free standing |
| Defrost | Automatic |
| Cooling type | Fan assisted |
| Hinge type | Standard |
| Hinge position | Right |



Wine cellar compartment features



| | |
|-----------------------------------------|---------------------------|
| Number of fixed shelves | 1 |
| Number of removable shelves | 5 |
| Number of removable and folding shelves | 1 |
| Shelves material | Wood |
| Adjustable shelves | Yes |
| Type of internal light | Led |
| Air filter | Activated charcoal filter |

Programs/Functions



| | | | |
|-----------------|-------------------------------|-------------------|-----|
| Control setting | Control buttons | Control lock | Yes |
| Controls | External, in the lower socket | Temperature Alarm | Yes |
| Display | 7 digits LED | Door open alarm | Yes |

Technical Features

| | | | |
|------------------------------|------------|---------------------------------------|--------------|
| Adjustable temperature zones | 2 | Refrigerant gas type | R600a |
| Temperature range | 5-22 °C | Refrigerant Quantity (gr) | 80 g |
| Type of temperature control | Electronic | Foam agent | Cyclopentane |
| Anti-UV door glass | Yes | Metal panel on the back of the fridge | Metal |
| | | Adjustable feet | 2 Front |

| | | | |
|-----------------------------------|--------------------------|--------------------------|-------------|
| Integrated heating element | Yes | Door opening type | With handle |
| Number of compressors | 1 | | |
| Compressor type | Low vibration compressor | | |

Performance / Energy Label - Reg. 2019





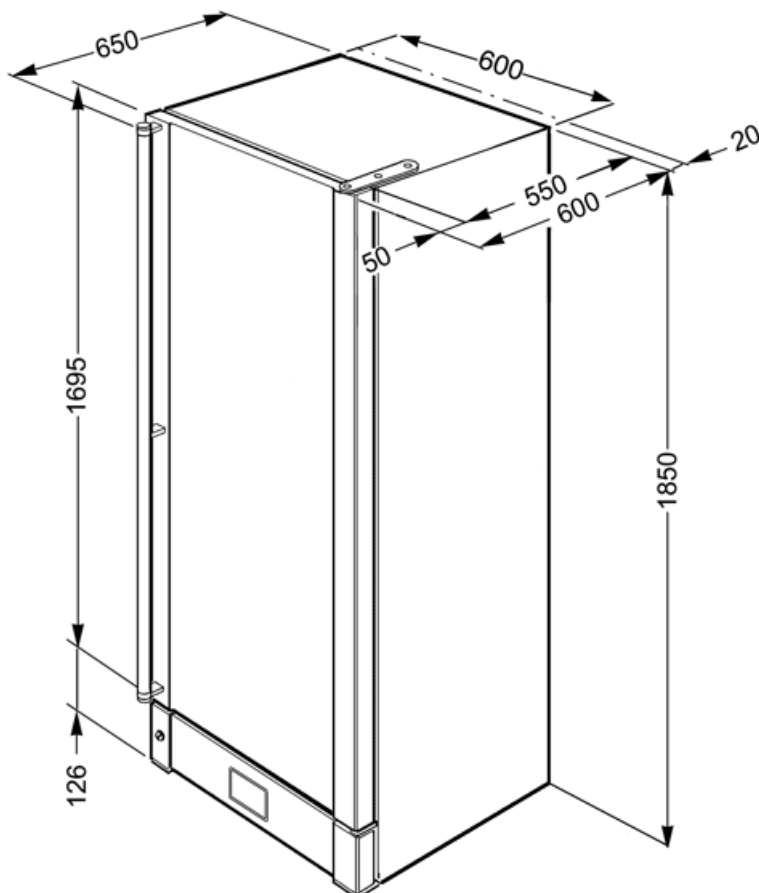

| | | | |
|----------------------------------------------------------------------------------|-----------|---------------------------------------------------------------------------------------|------------------|
|  | | | |
| Annual energy consumption | 181 kWh/a | Sum of the volumes of the chill compartment(s) and the unfrozen compartment(s) | 368 l |
| Energy efficiency class | G | Climate class | SN, N, ST |
| Airborne acoustical noise emission class | D | EEL | 179 % |
| Total net volume | 368 l | Noise level | 42 dB(A) re 1 pW |

Electrical Connection

| | | | |
|-------------------------------------|-----------|-----------------------|--------------|
| Electrical connection rating | 200 W | Frequency (Hz) | 50 Hz |
| Current | 1 A | Plug | (F;E) Schuko |
| Voltage (V) | 220-240 V | | |



Symbols glossary

- | | | | |
|----------------------------------------------------------------------------------|--------------------------------------------------------------------------------------------------------------------|-----------------------------------------------------------------------------------|--------------------------------------------------------------------------------------------------------------------------------------------|
|  | Energy efficiency class A |  | The automatic defrost system works by automatically defrosting at regular intervals eliminating the need to defrost altogether. |
|  | LED display: to show programmes, functions and options selected and the time to the end of the cycle. |  | Ventilated: Forced distribution of cold air in the refrigerator compartment, which allows even temperature distribution within the fridge. |
|  | Fingerprint proof stainless steel: Fingerprint proof stainless steel keeps stainless steel looking as good as new. |  | LED interior lighting: is a more energy efficient and long lasting way of illuminating the interior of the appliance. |
|  | Energy efficiency class G | | |