

SCV115A



Familie	Wijnklimaatkast
Installatie	Vrijstaand
Ontdooien	Automatisch
Type koelen	Geventileerd
Type scharnier	Standaard
Positie scharnier	Rechts



Eigenschappen compartimenten



Aantal vaste legplanken	1
Aantal uitneembare legplanken	5
Aantal uitneembare legplanken	1
Materiaal legplanken	Hout
Aanpasbare legplanken	Ja
Type interne verlichting	LED
Luchtfilter	Koolstoffilter

Programma's/Functies



Bediening	Bedieningsknoppen	Kinderbeveiliging	Ja
Type bediening	Buitenkant onderaan	Temperature Alarm	Ja
Display	7 digits LED	Alarm open deur	Ja

Technische specificaties

Aanpasbare temperatuurzones	2	Type koelgas	R600a
Temperatuur	5-22 °C	Hoeveelheid koelmiddel	80 g
Type temperatuurcontrole	Elektronisch	Schuimmiddel	Cyclopentaan
Anti-UV glazen deur	Ja	Metalen paneel op achterzijde koelkast	Plaatstaal
Geïntegreerd warmte-element	Ja	Aanpasbare voetjes	2 vooraan
		Opening deur	Met handvat

Aantal compressoren	1
Type compressor	Compressor lage vibraties

Prestaties/Energie label - Reg. 2019





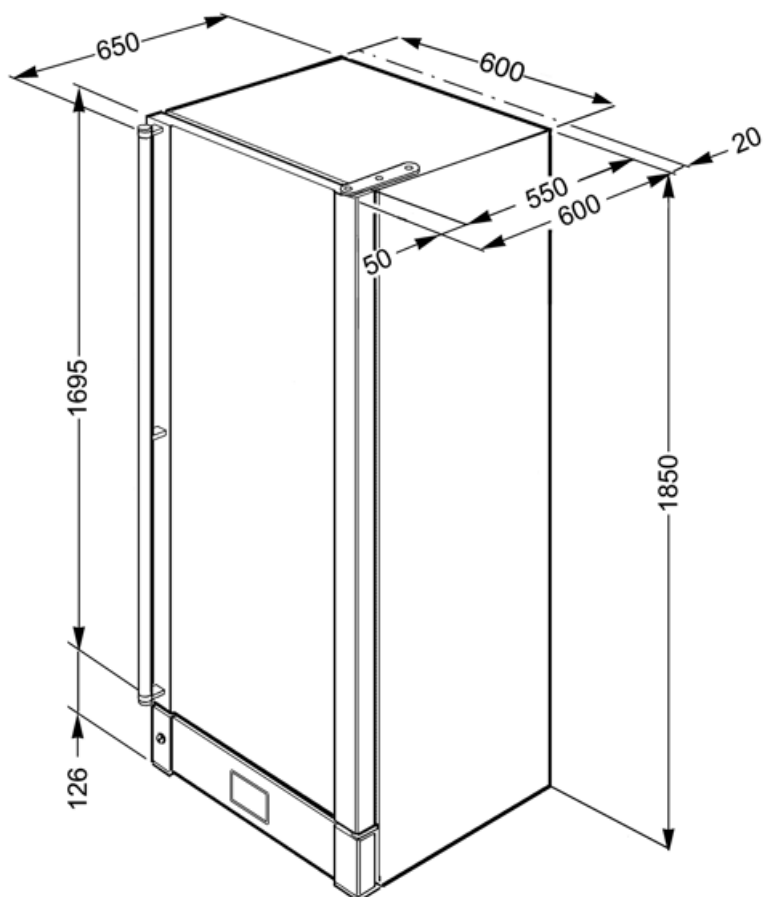

			
Annual energy consumption	181 kWh/jaar	Netto inhoud koelgedeeltes	368 l
Energie-efficiëntieklasse	G	Klimaatklasse	SN, N, ST
Emissieklasse voor akoestisch luchtgeluid	D	EEl	179 %
Totaal netto volume	368 l	Geluidsniveau	42 dB(A) re 1 pW

Elektrische aansluiting

Nominale aansluitwaarde	200 W	Frequentie (Hz)	50 Hz
Stroom (A)	1 A	Stekker	(F;E) Schuko
Spanning (V)	220-240 V		



Symbols glossary

-  Energy efficiency class A
-  LED display: to show programmes, functions and options selected and the time to the end of the cycle.
-  Fingerprint proof stainless steel: Fingerprint proof stainless steel keeps stainless steel looking as good as new.
-  Energie-efficiëntieklasse
-  The automatic defrost system works by automatically defrosting at regular intervals eliminating the need to defrost altogether.
-  Geventileerd: een geforceerde verdeling van koude lucht in het koelkast compartiment, die een gelijke temperatuurverdeling verzekert in de koelkast.
-  LED interior lighting: is a more energy efficient and long lasting way of illuminating the interior of the appliance.