

# SCV115AS



Product Family	Wine Cooler
Installation	Free standing
Defrost	Automatic
Cooling type	Fan assisted
Hinge type	Standard
Hinge position	Left



## Wine cellar compartment features



Number of fixed shelves	1
Number of removable shelves	5
Number of removable and folding shelves	1
Shelves material	Wood
Adjustable shelves	Yes
Type of internal light	LED
Air filter	Activated charcoal filter

## Programs / Functions



Control setting	Control buttons	Control lock	Yes
Controls	External, in the lower socket	Temperature Alarm	Yes
Display	7 digits LED	Door open alarm	Yes

## Technical Features

Adjustable temperature zones	2	Compressor type	Low vibration compressor
Temperature range	5-22 °C	Refrigerant gas type	R600a
Type of temperature control	Electronic	Refrigerant Quantity (gr)	80 g
Anti-UV door glass	Yes	Foam agent	Cyclopentane
		Metal panel on the back of the fridge	Metal

**Integrated heating element** Yes  
**Number of compressors** 1

**Adjustable feet** 2 Front

## Performance / Energy Label NEW

	<b>Annual energy consumption</b>	181 KWh/year	<b>Sum of the volumes of the chill compartment(s) and the unfrozen compartment(s)</b>	368 l
	<b>Energy efficiency class</b>	G	<b>Climatic class</b>	SN, N, ST
	<b>Airborne acoustical noise emission class</b>	D	<b>EEl</b>	179 %
	<b>Total volume</b>	368 l	<b>Noise level</b>	42 dB(A) re 1pW





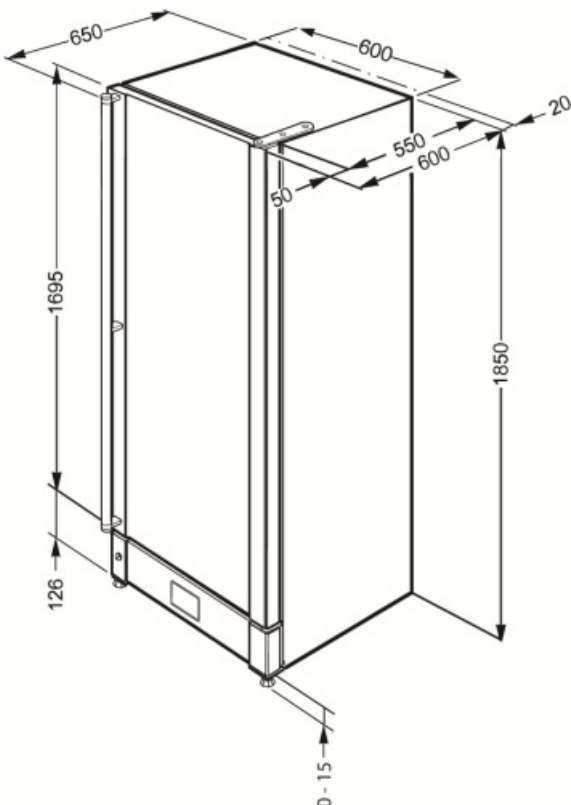

## Electrical Connection

**Plug** (F;E) Schuko  
**Nominal power** 200 W  
**Current** 1 A

**Voltage (V)** 220-240 V  
**Frequency (Hz)** 50 Hz



## Symbols glossary

-  A: Product drying performance, measured from A+++ to D / G depending on the product family
-  LED display: to show programmes, functions and options selected and the time to the end of the cycle.
-  Fingerprint proof stainless steel: Fingerprint proof stainless steel keeps stainless steel looking as good as new.
-  Energy efficiency class G
-  The automatic defrost system works by automatically defrosting at regular intervals eliminating the need to defrost altogether.
-  Ventilated: Forced distribution of cold air in the refrigerator compartment, which allows even temperature distribution within the fridge.
-  LED interior lighting: is a more energy efficient and long lasting way of illuminating the interior of the appliance.