

# SCV115AS



Family	Adega
Installation	Free standing
Defrost	Automatic
Cooling type	Fan assisted
Hinge type	Standard
Hinge position	Left
Reversible door	No



## Wine cellar compartment features



Number of fixed shelves	1
Number of removable shelves	5
Number of removable and folding shelves	1
Shelves material	Wood
Adjustable shelves	Yes
Removable shelves on telescopic guide rails	No
Type of internal light	Led
Air filter	Activated charcoal filter

## Programs/Functions



Control setting	Control buttons	Temperature Alarm	Yes
Controls	External, in the lower socket	Door open alarm	Yes
Display	7 digits LED	Humidity level setting	No
Control lock	Yes		

## Technical Features

Adjustable temperature zones	2	Refrigerant gas type	R600a
Temperature range	5-22 °C	Refrigerant Quantity (gr)	80 g
Type of temperature control	Electronic	Espuma expansiva de aislamiento	Ciclopentano

Anti-UV door glass	Yes	Painel de metal na parte de trás da geladeira	Metal
Integrated heating element	Yes	Adjustable feet	2 Front
Number of compressors	1	Door opening type	With handle
Compressor type	Low vibration compressor		

## Etiqueta de Desempenho / Energia - Reg. 2019





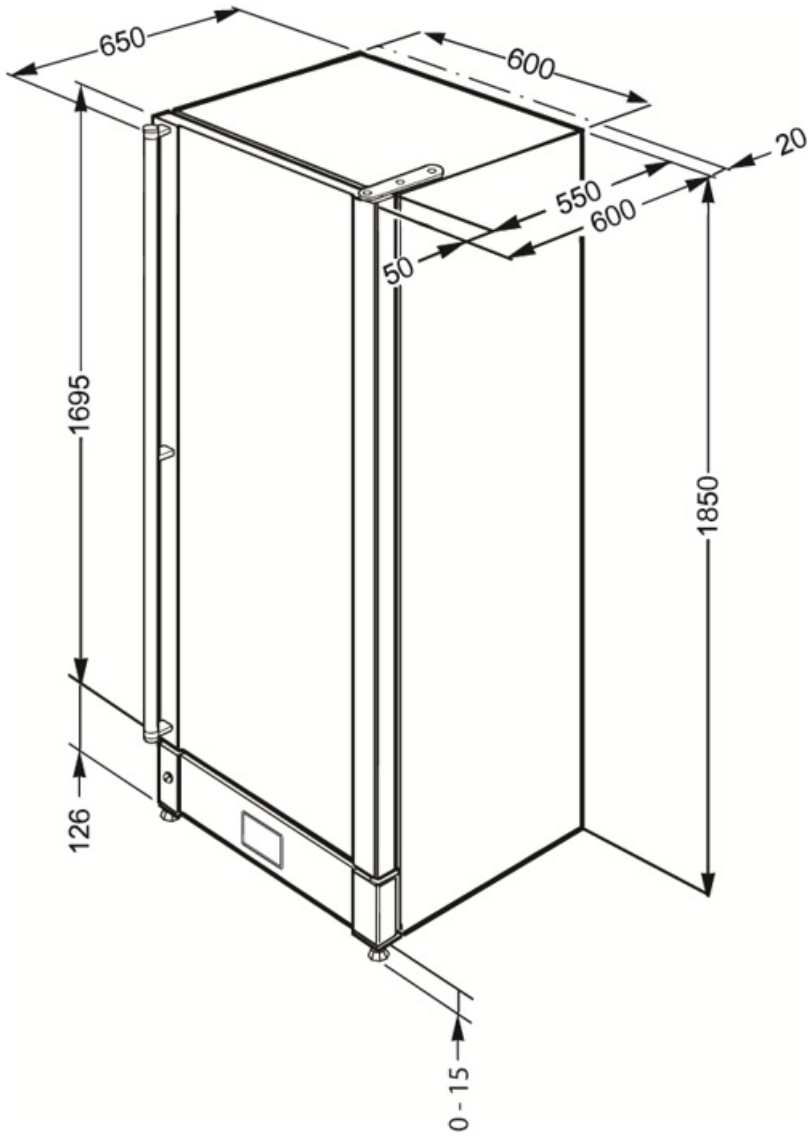

			
Consumo de energia anual	181 kWh/a	Soma dos volumes do(s) compartimento(s) refrigerado(s) e do(s) compartimento(s) não congelado(s)	368 l
Classe de eficiência energética	G	Classe climática	SN, N, ST
Classe de emissão de ruído acústico aerotransportado	D	EEl	179 %
Volume líquido total	368 l	Noise level	42 dB(A) re 1 pW

## Electrical Connection

Plug	(F;E) Schuko	Voltage (V)	220-240 V
Electrical connection rating	200 W	Frequency (Hz)	50 Hz
Current	1 A		



## Symbols glossary

-  R: Desempenho de secagem do produto, medido de A++ a D/G, dependendo da família de produtos
-  Display LED: para mostrar os programas, funções e opções selecionadas e o tempo até ao final do ciclo.
-  Aço inoxidável à prova de dedadas: O aço inoxidável à prova de dedadas mantém o aço inoxidável com um aspeto novo.
-  Classe de eficiência energética G
-  O sistema de descongelamento automático funciona descongelando automaticamente em intervalos regulares, eliminando a necessidade de descongelar completamente.
-  Ventilado: Distribuição forçada de ar frio no compartimento da geladeira, o que permite uma distribuição uniforme da temperatura dentro da geladeira.
-  Iluminação interior LED: é uma forma mais eficiente em termos energéticos e duradoura de iluminar o interior do aparelho.

## Benefit (TT)

---

### **External handle**

Handle with sober and elegant aesthetics, for easy door opening

### **UV-protected door glass**

The UV-protected door glass protects the bottles from the passage of light into the wine cooler for impeccable storage

### **Display Shelf**

The repositionable display shelf ensures that the best bottles are always in view, with the possibility of displaying magnum bottles as well

### **LED lights**

LED lights ensure perfect multi-level visibility inside the wine cooler

### **Activated charcoal air filter**

The activated charcoal air filter ensures excellent quality of the air and is easy to maintain

### **Low-vibration compressor**

The low-vibration compressor avoids exposing the bottles to prolonged vibrations, which could compromise the quality of the wine