

SCV115G



Installation	Free standing
Reference width	Until 60
Reference height	160 - 200
Defrost	Automatic
Cooling type	Fan assisted
Hinge type	Standard
Hinge position	Right
Reversible door	No



Wine cellar compartment features



Number of fixed shelves	1
Number of removable shelves	5
Number of removable and folding shelves	1
N° de lâmpadas	1
Shelves material	Wood
Adjustable shelves	Yes
Removable shelves on telescopic guide rails	No
Type of internal light	Led
Air filter	Activated charcoal filter

Programs/Functions



Control setting	Control buttons	Temperature Alarm	Yes
Controls	Inner, in the cellar compartment	Door open alarm	Yes
Display	7 digits LED	Humidity level setting	No
Control lock	Yes		

Technical Features

Adjustable temperature zones	2	Compressor type	Low vibration compressor
Temperature range	5-22 °C	Refrigerant gas type	R600a
		Espuma expansiva de isolamento	Ciclopetano

Type of temperature control	Electronic	Painel de metal na parte de trás da geladeira	Metal
Anti-UV door glass	Yes	Adjustable feet	2 Front
Integrated heating element	Yes	Door opening type	With handle
Number of compressors	1		

Etiqueta de Desempenho / Energia - Reg. 2019





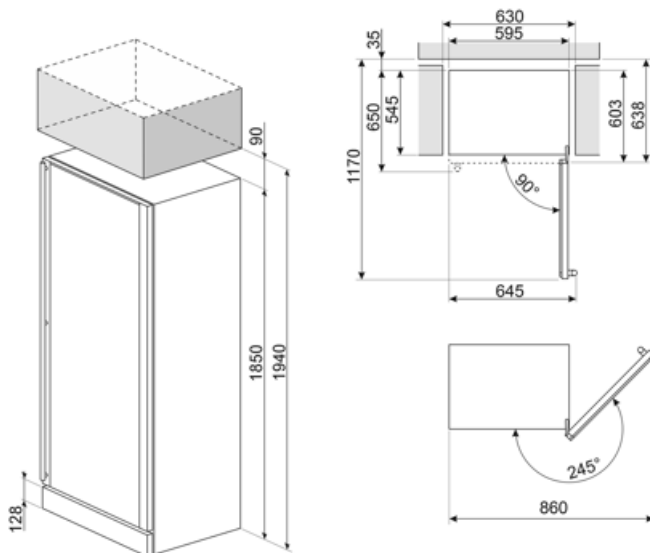

			
Consumo de energia anual	173 kWh/a	Soma dos volumes do(s) compartimento(s) refrigerado(s) e do(s) compartimento(s) não congelado(s)	368 l
Classe de eficiência energética	G	Classe climática	SN, N, ST
Classe de emissão de ruído acústico aerotransportado	C	EEl	171 %
Volume líquido total	368 l	Noise level	39 dB(A) re 1 pW

Electrical Connection

Plug	(F;E) Schuko	Voltage (V)	220-240 V
Electrical connection rating	200 W	Frequency (Hz)	50-60 Hz
Current	1 A		



Symbols glossary

- | | |
|--|---|
|  <p>O sistema de descongelamento automático funciona descongelando automaticamente em intervalos regulares, eliminando a necessidade de descongelar completamente.</p> |  <p>Display LED: para mostrar os programas, funções e opções selecionadas e o tempo até ao final do ciclo.</p> |
|  <p>Ventilado: Distribuição forçada de ar frio no compartimento da geladeira, o que permite uma distribuição uniforme da temperatura dentro da geladeira.</p> |  <p>Aço inoxidável à prova de dedadas: O aço inoxidável à prova de dedadas mantém o aço inoxidável com um aspeto novo.</p> |
|  <p>Iluminação interior LED: é uma forma mais eficiente em termos energéticos e duradoura de iluminar o interior do aparelho.</p> |  <p>Classe de eficiência energética G</p> |

Benefit (TT)

External handle

Handle with sober and elegant aesthetics, for easy door opening

UV-protected door glass

The UV-protected door glass protects the bottles from the passage of light into the wine cooler for impeccable storage

Display Shelf

The repositionable display shelf ensures that the best bottles are always in view, with the possibility of displaying magnum bottles as well

LED lights

LED lights ensure perfect multi-level visibility inside the wine cooler

Activated charcoal air filter

The activated charcoal air filter ensures excellent quality of the air and is easy to maintain

Low-vibration compressor

The low-vibration compressor avoids exposing the bottles to prolonged vibrations, which could compromise the quality of the wine