

SCV115GS



Installation	Free standing
Reference width	Until 60
Reference height	160 - 200
Defrost	Automatic
Cooling type	Fan assisted
Hinge type	Standard
Hinge position	Left



Wine cellar compartment features



Number of fixed shelves	1
Number of removable shelves	5
Number of removable and folding shelves	1
No. of lights	1
Shelves material	Wood
Adjustable shelves	Yes
Type of internal light	Led
Air filter	Activated charcoal filter

Programs/Functions



Control setting	Control buttons	Control lock	Yes
Controls	Inner, in the cellar compartment	Temperature Alarm	Yes
Display	7 digits LED	Door open alarm	Yes

Technical Features

Adjustable temperature zones	2	Compressor type	Low vibration compressor
Temperature range	5-22 °C	Refrigerant gas type	R600a
Type of temperature control	Electronic	Foam agent	Cyclopentane
		Metal panel on the back of the fridge	Metal

Anti-UV door glass	Yes	Adjustable feet	2 Front
Integrated heating element	Yes	Door opening type	With handle
Number of compressors	1		

Performance / Energy Label - Reg. 2019





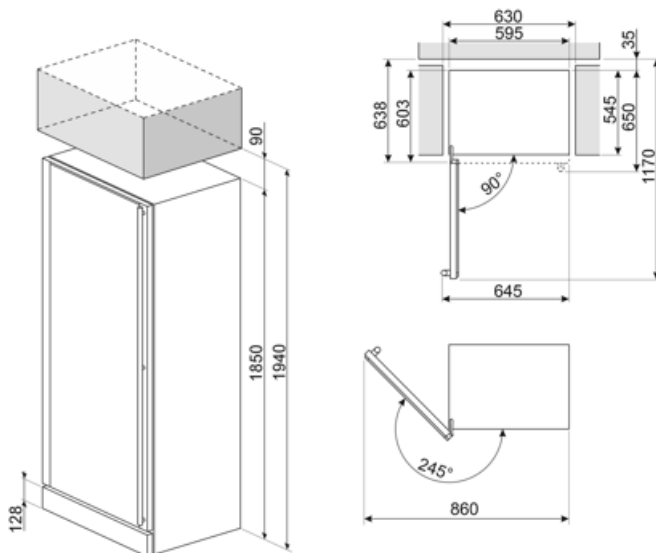

			
Max Capacity (bottles 0,75lt)	197	Sum of the volumes of the chill compartment(s) and the unfrozen compartment(s)	368 l
Annual energy consumption	173 kWh/a	Climate class	SN, N, ST
Energy efficiency class	G	EEL	171 %
Airborne acoustical noise emission class	C	Noise level	39 dB(A) re 1 pW
Total net volume	368 l		

Electrical Connection

Electrical connection rating	200 W	Frequency (Hz)	50-60 Hz
Current	1 A	Plug	(F;E) Schuko
Voltage (V)	220-240 V		



Symbols glossary

- | | | | |
|--|--|---|--|
|  | The automatic defrost system works by automatically defrosting at regular intervals eliminating the need to defrost altogether. |  | LED display: to show programmes, functions and options selected and the time to the end of the cycle. |
|  | Ventilated: Forced distribution of cold air in the refrigerator compartment, which allows even temperature distribution within the fridge. |  | Fingerprint proof stainless steel: Fingerprint proof stainless steel keeps stainless steel looking as good as new. |
|  | LED interior lighting: is a more energy efficient and long lasting way of illuminating the interior of the appliance. |  | Energy efficiency class G |