

SE232TX1



Product Family	Hob
Built-in type	Ultra-low profile or Fully Flushed
Dimensions	30 cm
Type	Ceramic
EAN code	8017709312053



Aesthetics



Aesthetic	Universale
Colour	Black
Finishing	Glass
Material	Glass
Glass type	Ceramic
Glass edge	Straight edge
Frame	Yes
Frame colour	Stainless Steel
Type of control setting	Digi Touch
LED colours	Red
Control knob position	Front
Serigraphy colour	Grey

Programme / Functions

No. of ceramic cook zones	2
Main on/off switch	Yes
Power levels	9

Options



Worktop Cut-Out	490x270 mm	Showroom Demo Option	Yes
End cooking timer	2		
Minute minder	1		

Control Lock / Child Safety Yes

Technical Features



Front-centre - 1200 kW - 14,5 cm
Rear-centre - 1700 kW - 12,0 - 18,0 cm

Automatic switch off when overheat Yes

Residual heat indicator Yes

Automatic switch off when overflow Yes

Electrical Connection

Electrical connection rating (W)	2900 W	Frequency (Hz)	50-60 Hz
Current	13 A	Power supply cable length	130 cm
Voltage (V)	220-240 V	Terminal box	3 poles
Type of electric cable installed	Yes, Single and Double phase		

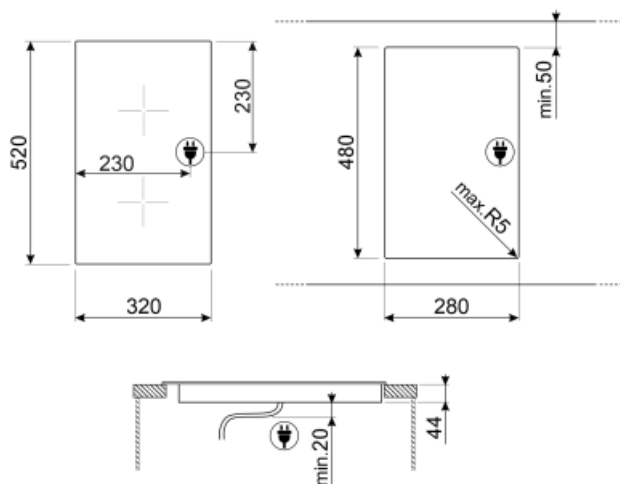







Not included accessories



SCRP

Non-scratch hob scraper - suitable for induction and ceramic hobs

Symbols glossary (TT)

- | | | | |
|--|---|---|---|
|  | Child lock: some models are fitted with a device to lock the programme/cycle so it cannot be accidentally changed. |  | Touch control |
|  | Overheat protection: The safety system that automatically turns off the hob in case of overheating of the control unit. |  | Glass ceramic: The base of the hob is made glass ceramic. Heating is performed by the heating elements Hi-Light. |
|  | Overfill protection: The special overfill protection shuts down the stove in the presence of overflow of liquids. |  | Indication of residual heat: After the glass ceramic hob is switched off the residual heat indicator shows which of the heating zones still remains hot. When the temperature drops below 60 ° C, the indicator goes out. |
|  | Timer: All ceramic hobs have a timer which automatically ends cooking after a preset time. | | |