

SE332EPB



Product Family	Hob
Built-in type	Ultra-low profile
Dimensions	30 cm
Power supply	Electric
Type	Ceramic
EAN code	8017709260545



Aesthetics



Aesthetic	Universale
Colour	Black
Finishing	Glass
Material	Glass
Glass type	Ceramic
Glass edge	Angled edge
Type of control setting	Digi Touch
Control knob position	Front
Logo	Silk screen
Serigraphy colour	Grey

Program / Functions



No. of ceramic cook zones	2
No. of cooking zones with booster	2
Main on/off switch	Yes
Power levels	9
Total no. of cook zones	2

Options



Worktop Cut-Out	490x270 mm
-----------------	------------

Keep warm automatic function Yes
 Showroom Demo Option Yes

Control Lock / Child Safety Yes
 Quick start Yes

Technical Features



Front-centre - Ceramic - Single - 1.20 kW - Ø 14.0 cm

Rear-centre - Ceramic - Double - 0.80 - 2.00 kW - Ø 11.0 - Ø 17.5 cm

Automatic switch off when overheat Yes

Residual heat indicator Yes

Automatic switch off when overflow Yes

Electrical Connection

Electrical connection rating (W) 3200 W
 Current 14 A
 Voltage (V) 220-240 V
 Type of electric cable installed Yes, Single phase

Frequency (Hz) 50/60 Hz
 Power supply cable length 150 cm
 Terminal box 3 poles
 Plug Not present

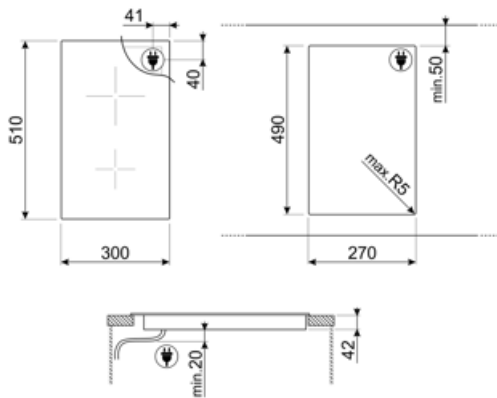











Compatible Accessories



SCRP

Non-scratch hob scraper - suitable for induction and ceramic hobs

Symbols glossary

	Power booster: option allows the zone to work at full power when very intense cooking is necessary.		Ultra-low profile: Installation of product with flat edge - height of 1 mm.
	Child lock: some models are fitted with a device to lock the programme/cycle so it cannot be accidentally changed.		This function allows you to keep cooked food warm without burner it
	Overheat protection: The safety system that automatically turns off the hob in case of overheating of the control unit.		Glass ceramic: The base of the hob is made glass ceramic. Heating is performed by the heating elements Hi-Light.
	Overfill protection: The special overfill protection shuts down the stove in the presence of overflow of liquids.		Quick Start function: the chosen temperature is reached faster. The heating element works at maximum power until the right temperature is reached.
	Indication of residual heat: After the glass ceramic hob is switched off the residual heat indicator shows which of the heating zones still remains hot. When the temperature drops below 60 ° C, the indicator goes out.		Touch control