

# SE364EMTB

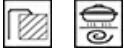

Product Family	Hob
Built-in type	Ultra-low profile
Dimensions	60 cm
Power supply	Electric
Type	Ceramic
EAN code	8017709234768



## Aesthetics



Aesthetic	Universale
Colour	Black
Finishing	Glass
Material	Glass
Glass type	Ceramic
Glass edge	Angled edge
Type of control setting	Digi Touch
Control knob position	Front
Serigraphy colour	Grey

## Programme / Functions



Total no. of cook zones	4
No. of ceramic cook zones	4
No. of cooking zones with booster	4
Main on/off switch	Yes
Power levels	9

## Options



Worktop Cut-Out	490x560 mm	Limited Power Consumption Mode	Yes
-----------------	------------	--------------------------------	-----

<b>Keep warm automatic function</b>	Yes	<b>Limited Power Consumption Mode in W</b>	2800, 4000 W
<b>End cooking timer</b>	4	<b>Showroom Demo Option</b>	Yes
<b>Minute minder</b>	1	<b>Control Lock / Child Safety</b>	Yes
<b>End of cooking alarm</b>	Yes	<b>Quick start</b>	Yes
<b>Residual time indicator</b>	Yes		

## Technical Features



Front-left - Ceramic - Double - 0.80 - 2.00 kW - Ø 12.4 - Ø 18.4 cm

Rear-left - Ceramic - Single - 1.20 kW - Ø 14.8 cm

Rear-right - Ceramic - Extendable - 1.10 - 2.00 kW - Ø 14.8 - 25.3x14.8 cm

Front-right - Ceramic - Single - 1.20 kW - Ø 14.8 cm

<b>Automatic switch off when overheat</b>	Yes	<b>Residual heat indicator</b>	Yes
<b>Automatic switch off when overflow</b>	Yes		

## Electrical Connection

<b>Electrical connection rating (W)</b>	6400 W	<b>Additional connection modalities</b>	Yes, Double and Three Phase
<b>Current</b>	19 A	<b>Frequency (Hz)</b>	50/60 Hz
<b>Voltage (V)</b>	220-240 V	<b>Power supply cable length</b>	150 cm
<b>Voltage 2 (V)</b>	380-415 V	<b>Terminal box</b>	6 poles
<b>Type of electric cable installed</b>	Yes, Single phase		

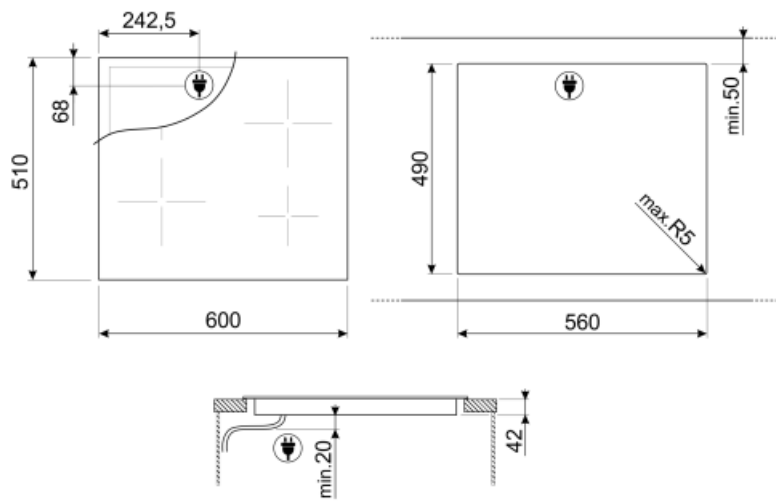

## Not included accessories













---



### SCRP

Non-scratch hob scraper - suitable for induction and ceramic hobs

## Symbols glossary (TT)

 <p><b>P</b> Power booster: option allows the zone to work at full power when very intense cooking is necessary.</p>	 <p>Ultra-low profile: Installation of product with flat edge - height of 1 mm.</p>
 <p>Child lock: some models are fitted with a device to lock the programme/cycle so it cannot be accidentally changed.</p>	 <p>DIGI touch Touch control</p>
 <p>ECO-logic: option allows you to restrict the power limit of the appliance real energy saving.</p>	 <p>This function allows you to keep cooked food warm without burner it</p>
 <p>Overheat protection: The safety system that automatically turns off the hob in case of overheating of the control unit.</p>	 <p>Glass ceramic: The base of the hob is made glass ceramic. Heating is performed by the heating elements Hi-Light.</p>
 <p>Overfill protection: The special overfill protection shuts down the stove in the presence of overflow of liquids.</p>	 <p>Quick Start function: the chosen temperature is reached faster. The heating element works at maximum power until the right temperature is reached.</p>
 <p>Indication of residual heat: After the glass ceramic hob is switched off the residual heat indicator shows which of the heating zones still remains hot. When the temperature drops below 60 ° C, the indicator goes out.</p>	 <p>Time elapsed: shows how long the cooking zone has been in use.</p>
 <p>Timer: All ceramic hobs have a timer which automatically ends cooking after a preset time.</p>	