

## SE364ETB



Product familie

Type

Afmeting

Voeding

Type

EAN-code

Kookplaat

Vlak opbouw

60 cm

Elektrisch

Keramisch

8017709234737



## Design



Design

Kleur

Afwerking

Materiaal

Type glas

Glazen rand

Bediening

Positie bediening

Logo

Kleur serigrafie

Universeel

Zwart

Glas

Glas

Keramisch

Facetrand

Digi touch multi slider

Vooraan

Geëtst

Grijs

## Program / Functions



Aantal keramische kookzones

4

Aantal kookzones met booster

4

Hoofdtoets aan/uit

Ja

Vermogenniveaus

9

Totaal aantal kookzones

4

## Opties



Worktop Cut-Out

490x560 mm

ECO-Logic optie

Ja

Warmhoudfunctie	Ja	Beperkt vermogensverbruik	2800, 4000 W
Automatische uitschakeling	4	Showroom demo optie	Ja
Timer	1	Kinderbeveiliging	Ja
Geluidssignaal einde kooktijd	Ja	Quick start	Ja
Resttijd indicator	Ja		

## Technische specificaties



Linksvoor - Keramisch - enkel - 1.80 kW - Ø 18.4 cm

Linksachter - Keramisch - enkel - 1.20 kW - Ø 14.8 cm

Rechtsachter - Keramisch - dubbel - 1.00 - 2.20 kW - Ø 14.8 - Ø 21.4 cm

Rechtsvoor - Keramisch - enkel - 1.20 kW - Ø 14.8 cm

Automatisch uitschakelen i.g.v. oververhitting	Ja	Restwarmte indicator	Ja
--	----	----------------------	----

Automatisch uitschakelen i.g.v. overkoken	Ja
---	----

## Elektrische aansluiting

Nominale aansluitwaarde	6400 W	Type of electric cable supplied	Yes, Three and Single/Two-phase
Stroom	19 A	Frequentie	50/60 Hz
Spanning (V)	220-240 V	Lengte voedingskabel	150 cm
Spanning 2 (V)	380-415 V	Aansluiting	6 polig
Type stroomkabel	No	Stekker	Nee
Type stroomkabel	Dubbel universeel		

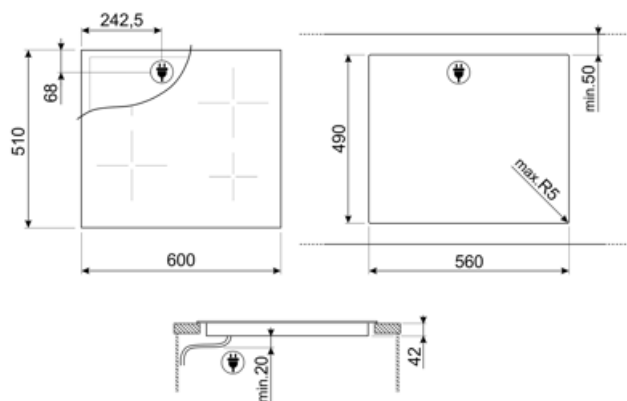

---

## Compatible Accessories













---



**SCRP**

Schraper voor inductie- en vitrokeramische kookplaten

## Symbols glossary

	Power booster: option allows the zone to work at full power when very intense cooking is necessary.		Ultra-low profile: Installation of product with flat edge - height of 1 mm.
	Sommige modellen zijn voorzien van een functie om het programma/de cyclus te blokkeren zodat het niet per ongeluk kan aangepast worden.		Touch control
	ECO-logic: option allows you to restrict the power limit of the appliance real energy saving.		This function allows you to keep cooked food warm without burner it
	Overheat protection: The safety system that automatically turns off the hob in case of overheating of the control unit.		Glass ceramic: The base of the hob is made glass ceramic. Heating is performed by the heating elements Hi-Light.
	Overfill protection: The special overfill protection shuts down the stove in the presence of overflow of liquids.		Quick Start function: the chosen temperature is reached faster. The heating element works at maximum power until the right temperature is reached.
	Indication of residual heat: After the glass ceramic hob is switched off the residual heat indicator shows which of the heating zones still remains hot. When the temperature drops below 60 ° C, the indicator goes out.		Time elapsed: shows how long the cooking zone has been in use.
	Timer: All ceramic hobs have a timer which automatically ends cooking after a preset time.		