

SE364ETD

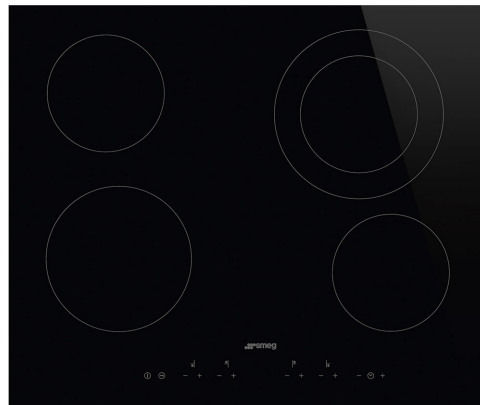

Product familie	Kookplaat
Type	Standaard opbouw of vlakbouw
Afmeting	60 cm
Voeding	Elektrisch
Type	Keramisch
EAN-code	8017709233730



Design



Design	Universeel
Kleur	Zwart
Afwerking	Glas
Materiaal	Glas
Type glas	Keramisch
Glazen rand	Rechte rand
Bediening	Digi touch multi slider
Positie bediening	Vooraan
Kleur serigrafie	Grijs

Programma's / Functies



Totaal aantal kookzones	4
Aantal keramische kookzones	4
Aantal kookzones met booster	4
Hoofdtoets aan/uit	Ja
Vermogenniveaus	9

Opties



Worktop Cut-Out	490x560 mm	ECO-Logic optie	Ja
-----------------	------------	-----------------	----

Warmhoudfunctie	Ja	Beperkt vermogensverbruik	2800, 4000 W
Automatische uitschakeling	4	Showroom demo optie	Ja
Timer	1	Kinderbeveiliging	Ja
Geluidssignaal einde kooktijd	Ja	Quick start	Ja
Resttijd indicator	Ja		

Technische specificaties



Linksvoor - Keramisch - enkel - 1.80 kW - Ø 18.4 cm

Linksachter - Keramisch - enkel - 1.20 kW - Ø 14.8 cm

Rechtsachter - Keramisch - dubbel - 1.00 - 2.20 kW - Ø 14.8 - Ø 21.4 cm

Rechtsvoor - Keramisch - enkel - 1.20 kW - Ø 14.8 cm

Automatisch uitschakelen i.g.v. oververhitting	Ja	Restwarmte indicator	Ja
Automatisch uitschakelen i.g.v. overkoken	Ja		

Elektrische aansluiting

Nominale aansluitwaarde	6400 W	Type of electric cable supplied	Yes, Three and Single/Two-phase
Stroom	19 A	Frequentie	50/60 Hz
Spanning (V)	220-240 V	Lengte voedingskabel	150 cm
Spanning 2 (V)	380-415 V	Aansluiting	6 polig
Type stroomkabel	Dubbel universeel		

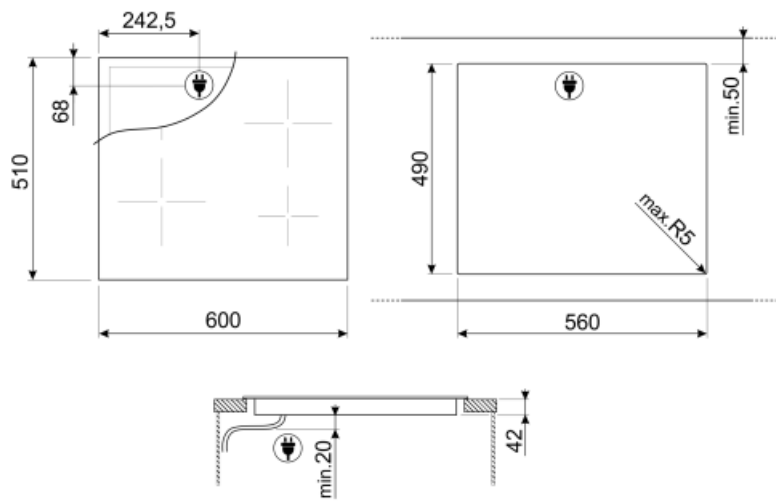













Not included accessories



SCRP

Schraper voor inductie- en vitrokeramische kookplaten

Symbols glossary (TT)

	Power booster: option allows the zone to work at full power when very intense cooking is necessary.		Sommige modellen zijn voorzien van een functie om het programma/de cyclus te blokkeren zodat het niet per ongeluk kan aangepast worden.
	ECO-logic: option allows you to restrict the power limit of the appliance real energy saving.		This function allows you to keep cooked food warm without burner it
	Overheat protection: The safety system that automatically turns off the hob in case of overheating of the control unit.		Touch control
	Glass ceramic: The base of the hob is made glass ceramic. Heating is performed by the heating elements Hi-Light.		Overfill protection: The special overfill protection shuts down the stove in the presence of overflow of liquids.
	Quick Start function: the chosen temperature is reached faster. The heating element works at maximum power until the right temperature is reached.		Indication of residual heat: After the glass ceramic hob is switched off the residual heat indicator shows which of the heating zones still remains hot. When the temperature drops below 60 ° C, the indicator goes out.
	Time elapsed: shows how long the cooking zone has been in use.		Timer: All ceramic hobs have a timer which automatically ends cooking after a preset time.