

# SE364TD

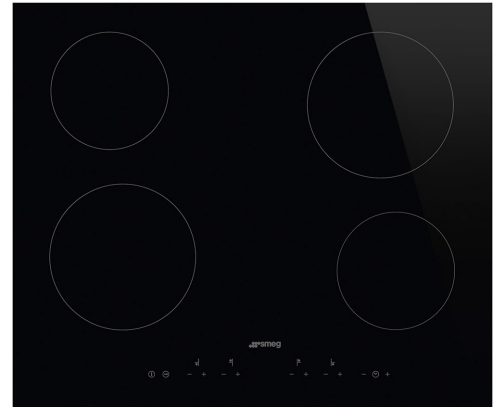

|                       |                                    |
|-----------------------|------------------------------------|
| <b>Product Family</b> | Hob                                |
| <b>Built-in</b>       | Ultra-low profile or Fully Flushed |
| <b>Dimensions</b>     | 60 cm                              |
| <b>Power supply</b>   | Electric                           |
| <b>Type</b>           | Ceramic                            |
| <b>EAN code</b>       | 8017709234720                      |



## Aesthetics



|                                |               |
|--------------------------------|---------------|
| <b>Aesthetics</b>              | Universal     |
| <b>Colour</b>                  | Black         |
| <b>Finishing</b>               | Glass         |
| <b>Material</b>                | Glass         |
| <b>Glass Type</b>              | Ceramic       |
| <b>Glass edge</b>              | Straight edge |
| <b>Type of control setting</b> | Touch control |
| <b>Control knobs position</b>  | Front         |
| <b>Serigraphy colour</b>       | Grey          |

## Programs / Functions



|  |     |
|--|-----|
| <b>Total no. of cook zones</b>           | 4   |
| <b>No. of ceramic cook zones</b>         | 4   |
| <b>No. of cooking zones with booster</b> | 4   |
| <b>Main on/off switch</b>                | Yes |
| <b>Power levels</b>                      | 9   |

## Options



|                         |            |                                       |     |
|-------------------------|------------|---------------------------------------|-----|
| <b>Standard cut out</b> | 490x560 mm | <b>Limited Power Consumption Mode</b> | Yes |
|-------------------------|------------|---------------------------------------|-----|

|                               |     |                                     |              |
|-------------------------------|-----|-------------------------------------|--------------|
| Keep warm automatic function  | Yes | Limited Power Consumption Mode in W | 2800, 4000 W |
| End cooking timer             | 4   | Show Room Demo Option               | Yes          |
| Minute minder                 | 1   | Control Lock / Child Safety         | Yes          |
| End of cooking acoustic alarm | Yes | Quick start                         | Yes          |
| Residual time indicator       | Yes |                                     |              |

## Technical Features



Front left - Ceramic - single - 1.80 kW - Ø 18.4 cm  
 Rear left - Ceramic - single - 1.20 kW - Ø 14.8 cm  
 Rear right - Ceramic - single - 1.80 kW - Ø 18.4 cm  
 Front right - Ceramic - single - 1.20 kW - Ø 14.8 cm

Automatic switch off when overheat Yes

Residual heat indicator Yes

Automatic switch off when overflow Yes

## Electrical Connection

|                   |           |                           |                  |
|-------------------|-----------|---------------------------|------------------|
| Nominal power (W) | 6000 W    | Type of electric cable    | Double universal |
| Current           | 18 A      | Frequency (Hz)            | 50/60 Hz         |
| Voltage (V)       | 220-240 V | Power supply cable length | 150 cm           |
| Voltage 2 (V)     | 380-415 V | Terminal Box              | 6 poles          |

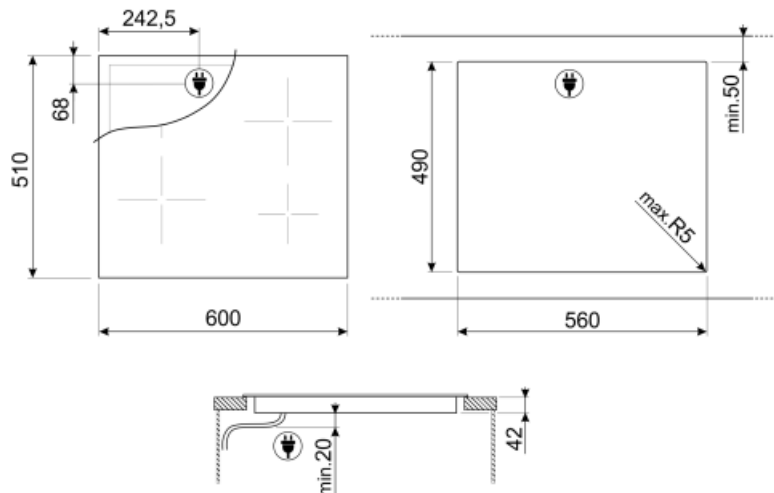

## Not included accessories

---















### SCRP

Induction and ceramic hobs and teppanyaki scraper

---

## Symbols glossary

---

|  |   |   |   |
|--|---|---|---|
|    | Power booster: option allows the zone to work at full power when very intense cooking is necessary.   |    | Child lock: some models are fitted with a device to lock the programme/cycle so it cannot be accidentally changed.  |
|    | ECO-logic: option allows you to restrict the power limit of the appliance real energy saving.   |    | Keep warm function: Keep warm function keeps the cooked food heated. In this mode the heating zone operates at a minimum capacity for 120 minutes and then turns off automatically. |
|    | Overheat protection: The safety system that automatically turns off the hob in case of overheating of the control unit.   |    | Glass ceramic: The base of the hob is made glass ceramic. Heating is performed by the heating elements Hi-Light.  |
|    | Overfill protection: The special overfill protection shuts down the stove in the presence of overflow of liquids.   |    | Quick Start function: the chosen temperature is reached faster. The heating element works at maximum power until the right temperature is reached.                                  |
|    | Indication of residual heat: After the glass ceramic hob is switched off the residual heat indicator shows which of the heating zones still remains hot. When the temperature drops below 60 ° C, the indicator goes out. |    | Time elapsed: shows how long the cooking zone has been in use.  |
|  | Timer: All ceramic hobs have a timer which automatically ends cooking after a preset time.  |  | Touch control   |