

SE384EMTD

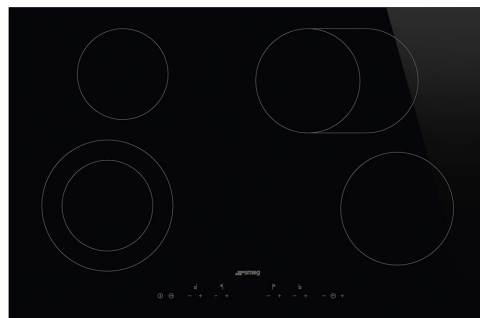

Familie	Kookplaat
Inbouw	Vlak opbouw of vlak inbouw
Afmeting	80 cm
Voeding	Elektrisch
Type	Keramisch
EAN-code	8017709240905



Design



Esthetiek	Universeel
Kleur	Zwart
Afwerking	Glas
Materiaal	Glas
Type glas	Keramisch
Glazen rand	Rechte rand
Type bediening	Touch control
Positie bediening	Voor
Kleur serigrafie	Grijs

Opties



Worktop Cut-Out	490x745 mm	ECO-Logic optie	Ja
Warmhoudfunctie	Ja	ECO-Logic optie - stappen	2800, 4000 W
Automatische uitschakeling	4	Showroom demo optie	Ja
Timer	1	Kinderbeveiliging	Ja
Akoestisch signaal einde kooktijd	Ja	Quick start	Ja

Technische specificaties



Linksvoor - Keramisch - dubbel - 1.00 - 2.20 kW - Ø 14.8 - Ø 21.4 cm

Linksachter - Keramisch - enkel - 1.20 kW - Ø 14.8 cm

Rechtsachter - Keramisch - uitbreidbaar - 1.40 - 2.20 kW - Ø 17.0 - 26.5x17.0 cm

Rechtsvoor - Keramisch - enkel - 1.80 kW - Ø 18.4 cm

Automatische stop bij oververhitting Ja

Restwarmte indicator Ja

Automatisch uitschakelen i.g.v. overkoken Ja

Elektrische aansluiting

Aansluitwaarde 7400 W
Stroom 22 A
Spanning (V) 220-240 V
Spanning 2 (V) 380-415 V
Type stroomkabel Eenfasig

Type stroomkabel Yes, Double and Three Phase
Frequentie 50/60 Hz
Lengte voedingskabel 150 cm
Connection box 6 polig

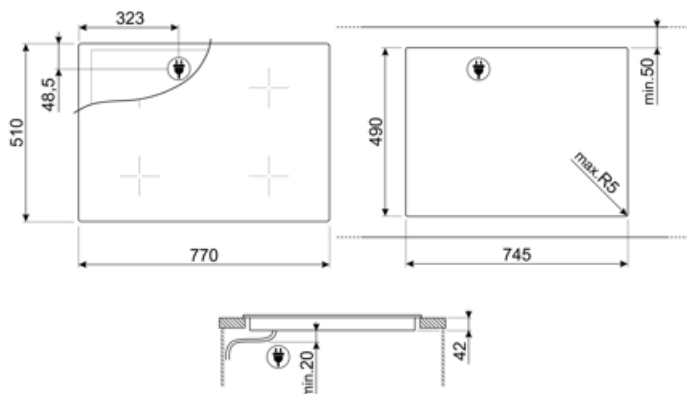











Accessoires niet inbegrepen



SCRP

Inductie- en keramische kookplaten en teppanyaki-schraper

Symbols glossary (TT)

	Powerbooster: optie zorgt ervoor dat de zone op vol vermogen werkt wanneer zeer intensief koken nodig is.		Kinderslot: sommige modellen zijn voorzien van een apparaat om het programma / de cyclus te vergrendelen zodat het niet kan per ongeluk veranderd
	Touch control		ECO-logic: optie stelt u in staat om de vermogenslimiet van de werkelijke energiebesparing van het apparaat te beperken
	This function allows you to keep cooked food warm without burner it		Overheat protection: The safety system that automatically turns off the hob in case of overheating of the control unit.
	Glass ceramic: The base of the hob is made glass ceramic. Heating is performed by the heating elements Hi-Light.		Overfill protection: The special overfill protection shuts down the stove in the presence of overflow of liquids.
	Quick Start function: the chosen temperature is reached faster. The heating element works at maximum power until the right temperature is reached.		Indication of residual heat: After the glass ceramic hob is switched off the residual heat indicator shows which of the heating zones still remains hot. When the temperature drops below 60 ° C, the indicator goes out.
	Timer: All ceramic hobs have a timer which automatically ends cooking after a preset time.		