

SE385EMTB

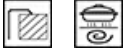

Product Family	Hob
Built-in	Ultra-low profile
Dimensions	80 cm
Power supply	Electric
Type	Ceramic
EAN code	8017709234751



Aesthetics



Aesthetics	Universal
Colour	Black
Finishing	Glass
Material	Glass
Glass Type	Ceramic
Glass edge	Angled edge
Type of control setting	Digi Touch
Control knobs position	Front
Logo	Silk screen
Serigraphy colour	Grey

Program / Functions



No. of ceramic cook zones	5
No. of cooking zones with booster	5
Power levels	9
Total no. of cook zones	5

Options



Standard cut out	490x745 mm	Limited Power Consumption Mode	Yes
-------------------------	------------	---------------------------------------	-----

Keep warm automatic function	Yes	Limited Power Consumption Mode in W	2800, 4000 W
End cooking timer	5	Show Room Demo Option	Yes
Minute minder	1	Control Lock / Child Safety	Yes
End of cooking acoustic alarm	Yes	Quick start	Yes
Residual time indicator	Yes		

Technical Features



Front left - Ceramic - single - Ø 18.4 cm

Rear left - Ceramic - single - Ø 14.8 cm

Central - Ceramic - extendable - 1.40 - 2.20 kW - Ø 17.0 - 26.5x17.0 cm

Front right - Ceramic - double - 1.00 - 2.20 kW - Ø 14.8 - Ø 21.4 cm

Front right - 1.20 kW - Ø 14.8 cm

Automatic switch off when overheat

Yes

Residual heat indicator

Yes

Automatic switch off when overflow

Yes

Electrical Connection

Nominal power (W)	8600 W
Current	24 A
Voltage (V)	220-240 V
Voltage 2 (V)	380-415 V
Type of electric cable	Single phase

Type of electric cable	Yes, Double and Three Phase
Frequency (Hz)	50/60 Hz
Power supply cable length	150 cm
Terminal Box	6 poles
Plug	No

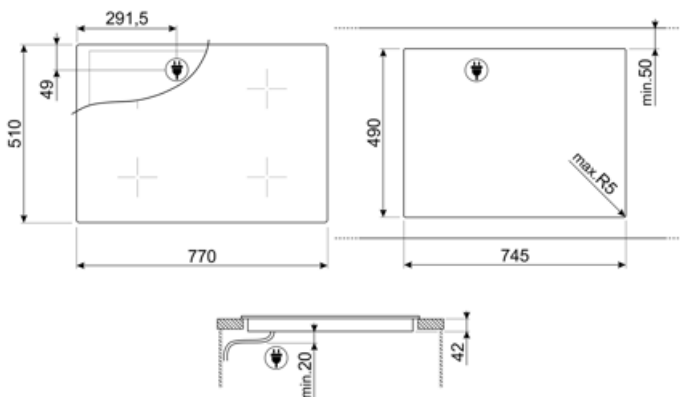













Compatible Accessories



SCRP

Induction and ceramic hobs and teppanyaki scraper

Symbols glossary

	Power booster: option allows the zone to work at full power when very intense cooking is necessary.		Ultra-low profile: Installation of product with flat edge - height of 1 mm.
	Child lock: some models are fitted with a device to lock the programme/cycle so it cannot be accidentally changed.		ECO-logic: option allows you to restrict the power limit of the appliance real energy saving.
	Keep warm function: Keep warm function keeps the cooked food heated. In this mode the heating zone operates at a minimum capacity for 120 minutes and then turns off automatically.		Overheat protection: The safety system that automatically turns off the hob in case of overheating of the control unit.
	Glass ceramic: The base of the hob is made glass ceramic. Heating is performed by the heating elements Hi-Light.		Overfill protection: The special overfill protection shuts down the stove in the presence of overflow of liquids.
	Quick Start function: the chosen temperature is reached faster. The heating element works at maximum power until the right temperature is reached.		Indication of residual heat: After the glass ceramic hob is switched off the residual heat indicator shows which of the heating zones still remains hot. When the temperature drops below 60 ° C, the indicator goes out.
	Time elapsed: shows how long the cooking zone has been in use.		Timer: All ceramic hobs have a timer which automatically ends cooking after a preset time.
	Touch control		