

SE385EMTB



Product familie

Type

Afmeting

Voeding

Type

EAN-code

Kookplaat

Vlak opbouw

80 cm

Elektrisch

Keramisch

8017709234751



Design



Design

Kleur

Afwerking

Materiaal

Type glas

Glazen rand

Bediening

Positie bediening

Kleur serigrafie

Universeel

Zwart

Glas

Glas

Keramisch

Facetrand

Digi touch multi slider

Vooraan

Grijs

Programma's / Functies



Totaal aantal kookzones

5

Aantal keramische kookzones

5

Aantal kookzones met booster

5

Vermogenniveaus

9

Opties



Worktop Cut-Out

490x745 mm

ECO-Logic optie

Ja

Warmhoudfunctie

Ja

Bepert
vermogensverbruik

2800, 4000 W

Automatische uitschakeling	5	Showroom demo optie	Ja
Timer	1	Kinderbeveiliging	Ja
Geluidssignaal einde kooktijd	Ja	Quick start	Ja
Resttijd indicator	Ja		

Technische specificaties



Linksvoor - Keramisch - enkel - Ø 18.4 cm

Linksachter - Keramisch - enkel - Ø 14.8 cm

Midden - Keramisch - uitbreidbaar - 1.40 - 2.20 kW - Ø 17.0 - 26.5x17.0 cm

Rechtsvoor - Keramisch - dubbel - 1.00 - 2.20 kW - Ø 14.8 - Ø 21.4 cm

Rechtsvoor - 1.20 kW - Ø 14.8 cm

Automatisch uitschakelen i.g.v. oververhitting	Ja	Restwarmte indicator	Ja
Automatisch uitschakelen i.g.v. overkoken	Ja		

Elektrische aansluiting

Nominale aansluitwaarde	8600 W	Type stroomkabel	Yes, Double and Three Phase
Stroom	24 A	Frequentie	50/60 Hz
Spanning (V)	220-240 V	Lengte voedingskabel	150 cm
Spanning 2 (V)	380-415 V	Aansluiting	6 polig
Type stroomkabel	Eenfasig		

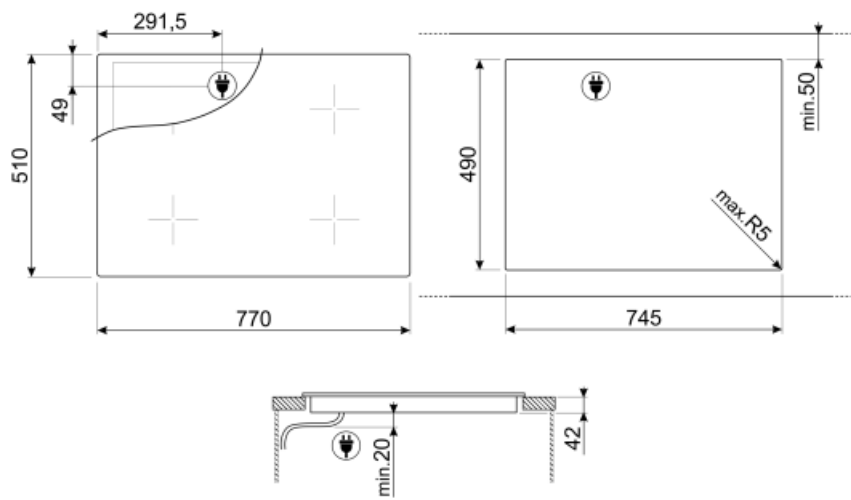













Not included accessories



SCRP

Schraper voor inductie- en vitrokeramische kookplaten

Symbols glossary (TT)

	Power booster: option allows the zone to work at full power when very intense cooking is necessary.		Ultra-low profile: Installation of product with flat edge - height of 1 mm.
	Sommige modellen zijn voorzien van een functie om het programma/de cyclus te blokkeren zodat het niet per ongeluk kan aangepast worden.		Touch control
	ECO-logic: option allows you to restrict the power limit of the appliance real energy saving.		This function allows you to keep cooked food warm without burner it
	Overheat protection: The safety system that automatically turns off the hob in case of overheating of the control unit.		Glass ceramic: The base of the hob is made glass ceramic. Heating is performed by the heating elements Hi-Light.
	Overfill protection: The special overfill protection shuts down the stove in the presence of overflow of liquids.		Quick Start function: the chosen temperature is reached faster. The heating element works at maximum power until the right temperature is reached.
	Indication of residual heat: After the glass ceramic hob is switched off the residual heat indicator shows which of the heating zones still remains hot. When the temperature drops below 60 ° C, the indicator goes out.		Time elapsed: shows how long the cooking zone has been in use.
	Timer: All ceramic hobs have a timer which automatically ends cooking after a preset time.		