

SE395ETB

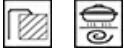

Product Family	Hob
Built-in	Ultra-low profile
Dimensions	90 cm
Power supply	Electric
Type	Ceramic
EAN code	8017709233754



Aesthetics



Aesthetics	Universal
Colour	Black
Finishing	Glass
Material	Glass
Glass Type	Ceramic
Glass edge	Angled edge
Type of control setting	Touch control
Control knobs position	Front
Serigraphy colour	Grey

Programs / Functions



Total no. of cook zones	5
No. of ceramic cook zones	5
No. of cooking zones with booster	5
Power levels	9

Options



Standard cut out	490x850 mm	Limited Power Consumption Mode	Yes
Keep warm automatic function	Yes		

End cooking timer	5	Limited Power	2800, 4000 W
Minute minder	1	Consumption Mode in W	
End of cooking acoustic alarm	Yes	Show Room Demo Option	Yes
Residual time indicator	Yes	Control Lock / Child Safety	Yes
		Quick start	Yes

Technical Features



Front left - Ceramic - double - Ø 12.4 - Ø 18.0 cm
 Rear left - Ceramic - single - Ø 15.0 cm
 Central - Ceramic - triple - Ø 15.0 - Ø 21.6 - Ø 29.0 cm
 Rear right - Ceramic - single - Ø 20.0 cm
 Front right - Ceramic - single - Ø 15.0 cm

Automatic switch off when overheat Yes
 Automatic switch off when overflow Yes

Residual heat indicator Yes

Electrical Connection

Nominal power (W)	9100 W	Type of electric cable	Double universal
Current	26 A	Frequency (Hz)	50/60 Hz
Voltage (V)	220-240 V	Power supply cable length	150 cm
Voltage 2 (V)	380-415 V	Terminal Box	6 poles

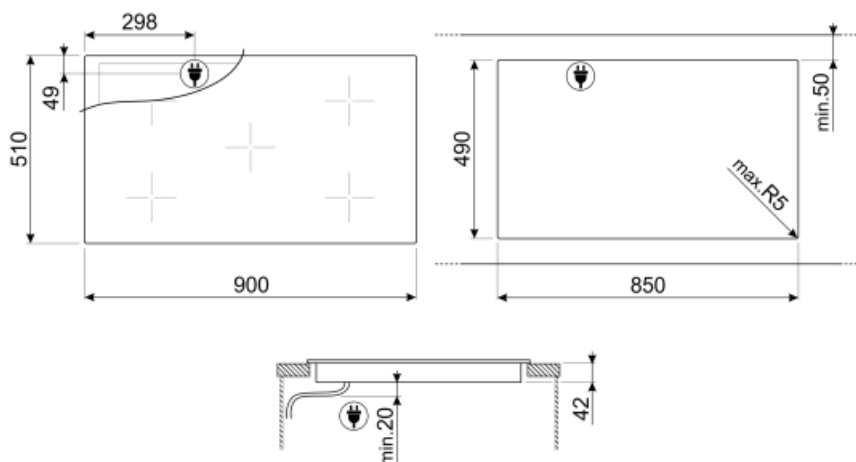













Not included accessories



SCRP

Induction and ceramic hobs and teppanyaki scraper

Symbols glossary

 <p>Power booster: option allows the zone to work at full power when very intense cooking is necessary.</p>	 <p>Ultra-low profile: Installation of product with flat edge - height of 1 mm.</p>
 <p>Child lock: some models are fitted with a device to lock the programme/cycle so it cannot be accidentally changed.</p>	 <p>ECO-logic: option allows you to restrict the power limit of the appliance real energy saving.</p>
 <p>Keep warm function: Keep warm function keeps the cooked food heated. In this mode the heating zone operates at a minimum capacity for 120 minutes and then turns off automatically.</p>	 <p>Overheat protection: The safety system that automatically turns off the hob in case of overheating of the control unit.</p>
 <p>Glass ceramic: The base of the hob is made glass ceramic. Heating is performed by the heating elements Hi-Light.</p>	 <p>Overfill protection: The special overfill protection shuts down the stove in the presence of overflow of liquids.</p>
 <p>Quick Start function: the chosen temperature is reached faster. The heating element works at maximum power until the right temperature is reached.</p>	 <p>Indication of residual heat: After the glass ceramic hob is switched off the residual heat indicator shows which of the heating zones still remains hot. When the temperature drops below 60 ° C, the indicator goes out.</p>
 <p>Time elapsed: shows how long the cooking zone has been in use.</p>	 <p>Timer: All ceramic hobs have a timer which automatically ends cooking after a preset time.</p>
 <p>Touch control</p>	