

# SE484EMTD



Product familie

Type

Afmeting

Voeding

Type

EAN-code

Kookplaat

Vlak opbouw

80 cm

Elektrisch

Keramisch

8017709324247



## Design



Design

Kleur

Afwerking

Materiaal

Type glas

Glazen rand

Bediening

Kleur LED

Positie bediening

Logo

Kleur serigrafie

Universeel

Zwart

Glas

Glas

Keramisch

Rechte rand

Compact Slider bediening

Rood

Vooraan

Geëst

Grijs

## Program / Functions



Aantal keramische kookzones

4

Aantal kookzones met booster

4

Hoofdtoets aan/uit

Ja

Vermogenniveaus

9

Totaal aantal kookzones

4

## Opties



Worktop Cut-Out	490x745 mm	ECO-Logic optie	Ja
Warmhoudfunctie	Ja	Beperkt vermogensverbruik	2800, 4000 W
Automatische uitschakeling	4	Showroom demo optie	Ja
Timer	1	Kinderbeveiliging	Ja
Geluidssignaal einde kooktijd	Ja	Quick start	Ja
Resttijd indicator	Ja		

## Technische specificaties



Linksvoor - Keramisch - dubbel - 2.30 kW - Ø 21.0 cm

Linksachter - Keramisch - enkel - 1.20 kW - Ø 15.0 cm

Rechtsachter - Keramisch - uitbreidbaar - 2.20 kW - Ø 17.0 cm

Rechtsvoor - Keramisch - enkel - 1.80 kW - Ø 18.5 cm

Automatisch uitschakelen i.g.v. oververhitting	Ja	Restwarmte indicator	Ja
Automatisch uitschakelen i.g.v. overkoken	Ja		

## Elektrische aansluiting

Nominale aansluitwaarde	7400 W	Type of electric cable supplied	No
Stroom	22 A	Frequentie	50/60 Hz
Spanning (V)	220-240 V	Lengte voedingskabel	150 cm
Spanning 2 (V)	380-415 V	Aansluiting	6 polig
Type stroomkabel	Eenfasig	Stekker	Nee
Type stroomkabel	Yes, Double and Three Phase		

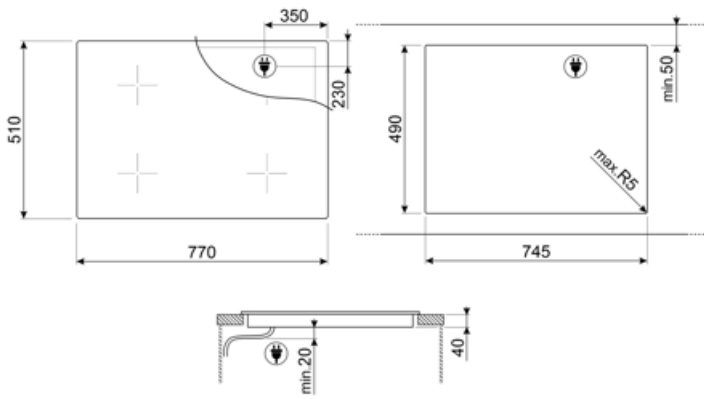

---

## Compatible Accessories













---



**SCRP**

Schraper voor inductie- en vitrokeramische kookplaten

## Symbols glossary

	Power booster: option allows the zone to work at full power when very intense cooking is necessary.		Ultra-low profile: Installation of product with flat edge - height of 1 mm.
	Sommige modellen zijn voorzien van een functie om het programma/de cyclus te blokkeren zodat het niet per ongeluk kan aangepast worden.		Compact Slider intuitive and easy to use
	ECO-logic: option allows you to restrict the power limit of the appliance real energy saving.		This function allows you to keep cooked food warm without burner it
	Overheat protection: The safety system that automatically turns off the hob in case of overheating of the control unit.		Glass ceramic: The base of the hob is made glass ceramic. Heating is performed by the heating elements Hi-Light.
	Overfill protection: The special overfill protection shuts down the stove in the presence of overflow of liquids.		Quick Start function: the chosen temperature is reached faster. The heating element works at maximum power until the right temperature is reached.
	Indication of residual heat: After the glass ceramic hob is switched off the residual heat indicator shows which of the heating zones still remains hot. When the temperature drops below 60 ° C, the indicator goes out.		Time elapsed: shows how long the cooking zone has been in use.
	Timer: All ceramic hobs have a timer which automatically ends cooking after a preset time.		