

# SE494EMTD

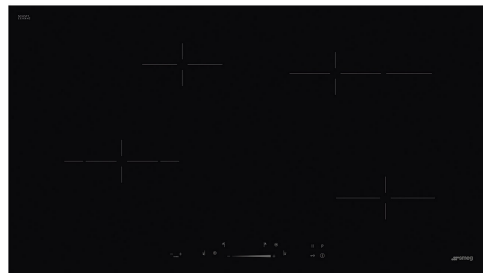

Product Family	Hob
Built-in type	Ultra-low profile
Dimensions	90 cm
Power supply	Electric
Type	Ceramic
EAN code	8017709324261



## Aesthetics



Aesthetic	Universale
Colour	Black
Finishing	Glass
Material	Glass
Glass type	Ceramic
Glass edge	Straight edge
Type of control setting	VTC controls
Slider	Red
Control knob position	Front
Logo	Silk screen
Serigraphy colour	Grey

## Program / Functions



No. of ceramic cook zones	4
No. of cooking zones with booster	4
Main on/off switch	Yes
Power levels	9
Total no. of cook zones	4

## Options



<b>Standard cut out</b>	490x850 mm	<b>Residual time indicator</b>	Yes
<b>Keep warm automatic function</b>	Yes	<b>Limited Power Consumption Mode</b>	Yes
<b>End cooking timer</b>	4	<b>Limited Power Consumption Mode in W</b>	2800, 4000 W
<b>Minute minder</b>	1	<b>Showroom Demo Option</b>	Yes
<b>End of cooking alarm</b>	Yes	<b>Control Lock / Child Safety</b>	Yes

## Technical Features



Front-left - Ceramic - Double - 2.30 kW - Ø 21.0 cm  
 Rear-left - Ceramic - Single - 1.20 kW - Ø 15.0 cm  
 Rear-right - Ceramic - Extendable - 2.20 kW - Ø 17.0 cm  
 Front-right - Ceramic - Single - 1.80 kW - Ø 18.5 cm

<b>Automatic switch off when overheat</b>	Yes	<b>Residual heat indicator</b>	Yes
<b>Automatic switch off when overflow</b>	Yes		

## Electrical Connection

<b>Electrical connection rating (W)</b>	7400 W	<b>Type of electric cable</b>	Yes, Double and Three Phase
<b>Current</b>	22 A	<b>Frequency (Hz)</b>	50/60 Hz
<b>Voltage (V)</b>	220-240 V	<b>Power supply cable length</b>	150 cm
<b>Voltage 2 (V)</b>	380-415 V	<b>Terminal box Plug</b>	6 poles No
<b>Type of electric cable</b>	Single phase		

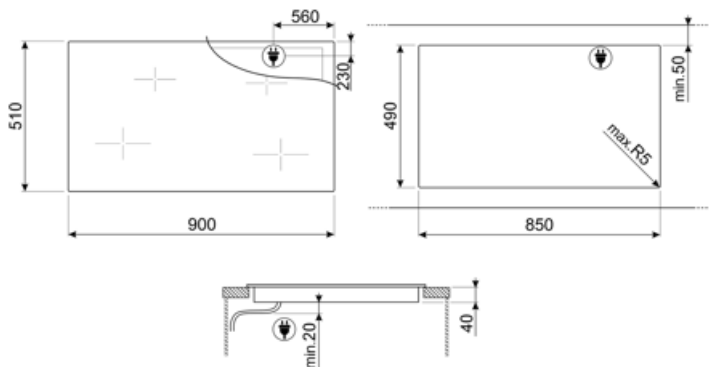

---

## Compatible Accessories













---



### SCRP

Induction and ceramic hobs and teppanyaki scraper

## Symbols glossary

	Power booster: option allows the zone to work at full power when very intense cooking is necessary.		Ultra-low profile: Installation of product with flat edge - height of 1 mm.
	Child lock: some models are fitted with a device to lock the programme/cycle so it cannot be accidentally changed.		ECO-logic: option allows you to restrict the power limit of the appliance real energy saving.
	Keep warm function: Keep warm function keeps the cooked food heated. In this mode the heating zone operates at a minimum capacity for 120 minutes and then turns off automatically.		Overheat protection: The safety system that automatically turns off the hob in case of overheating of the control unit.
	Glass ceramic: The base of the hob is made glass ceramic. Heating is performed by the heating elements Hi-Light.		Overfill protection: The special overfill protection shuts down the stove in the presence of overflow of liquids.
	Indication of residual heat: After the glass ceramic hob is switched off the residual heat indicator shows which of the heating zones still remains hot. When the temperature drops below 60 ° C, the indicator goes out.		Time elapsed: shows how long the cooking zone has been in use.
	Timer: All ceramic hobs have a timer which automatically ends cooking after a preset time.		Compact Slider intuitive and easy to use