

SE495ETD



Product Family	Hob
Built-in type	Ultra-low profile
Dimensions	90 cm
Power supply	Electric
Type	Ceramic
EAN code	8017709324254



Aesthetics



Aesthetic	Universale
Colour	Black
Finishing	Glass
Material	Glass
Glass type	Ceramic
Glass edge	Straight edge
Type of control setting	Compact Slider
LED colours	Red
Control knob position	Front
Logo	Silk screen
Serigraphy colour	Grey

Program / Functions



No. of ceramic cook zones	5
No. of cooking zones with booster	5
Power levels	9
Total no. of cook zones	5

Options



Worktop Cut-Out 490x850 mm

End cooking timer	5	Limited Power Consumption Mode	Yes
Minute minder	1	Limited Power Consumption Mode in W	2800, 4000 W
End of cooking alarm	Yes	Showroom Demo Option	Yes
Residual time indicator	Yes	Control Lock / Child Safety	Yes
		Quick start	Yes

Technical Features



Front-left - Ceramic - Double - Ø 18.5 cm
 Rear-left - Ceramic - Single - Ø 15.0 cm
 Central - Ceramic - Triple - - Ø 29.0 cm
 Rear-right - Ceramic - Single - Ø 20.0 cm
 Front-right - Ceramic - Single - Ø 15.0 cm

Automatic switch off when overheat

Yes

Residual heat indicator

Yes

Automatic switch off when overflow

Yes

Electrical Connection

Electrical connection rating (W)	9100 W	Additional connection modalities	Yes, Double and Three Phase
Current	26 A	Frequency (Hz)	50/60 Hz
Voltage (V)	220-240 V	Power supply cable length	150 cm
Voltage 2 (V)	380-415 V	Terminal box Plug	6 poles Not present
Type of electric cable installed	Yes, Single phase		

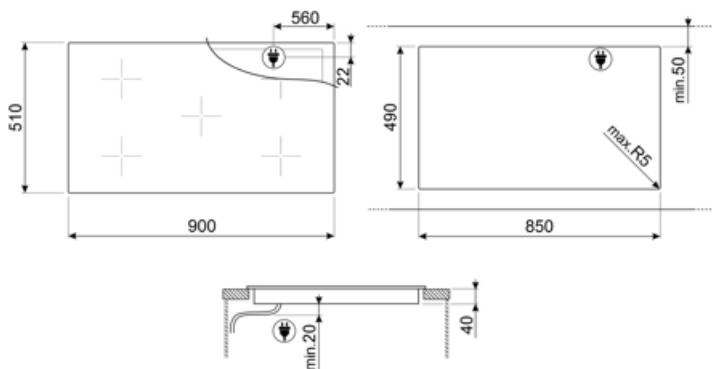













Compatible Accessories



SCRP

Non-scratch hob scraper - suitable for induction and ceramic hobs

Symbols glossary

	Power booster: option allows the zone to work at full power when very intense cooking is necessary.		Ultra-low profile: Installation of product with flat edge - height of 1 mm.
	Child lock: some models are fitted with a device to lock the programme/cycle so it cannot be accidentally changed.		ECO-logic: option allows you to restrict the power limit of the appliance real energy saving.
	Overheat protection: The safety system that automatically turns off the hob in case of overheating of the control unit.		Glass ceramic: The base of the hob is made glass ceramic. Heating is performed by the heating elements Hi-Light.
	Overfill protection: The special overfill protection shuts down the stove in the presence of overflow of liquids.		Quick Start function: the chosen temperature is reached faster. The heating element works at maximum power until the right temperature is reached.
	Indication of residual heat: After the glass ceramic hob is switched off the residual heat indicator shows which of the heating zones still remains hot. When the temperature drops below 60 ° C, the indicator goes out.		Time elapsed: shows how long the cooking zone has been in use.
	Timer: All ceramic hobs have a timer which automatically ends cooking after a preset time.		Compact Slider intuitive and easy to use