

SE495ETD



Product familie

Type

Afmeting

Voeding

Type

EAN-code

Kookplaat

Vlak opbouw

90 cm

Elektrisch

Keramisch

8017709324254



Design



Design

Kleur

Afwerking

Materiaal

Type glas

Glazen rand

Bediening

Kleur LED

Positie bediening

Logo

Kleur serigrafie

Universeel

Zwart

Glas

Glas

Keramisch

Rechte rand

Compact Slider bediening

Rood

Vooraan

Geëtst

Grijs

Program / Functions



Aantal keramische kookzones

5

Aantal kookzones met booster

5

Vermogenniveaus

9

Totaal aantal kookzones

5

Opties



Worktop Cut-Out

490x850 mm

ECO-Logic optie

Ja

Warmhoudfunctie	Ja	Beperkt vermogensverbruik	2800, 4000 W
Automatische uitschakeling	5	Showroom demo optie	Ja
Timer	1	Kinderbeveiliging	Ja
Geluidssignaal einde kooktijd	Ja	Quick start	Ja
Resttijd indicator	Ja		

Technische specificaties



Linksvoor - Keramisch - dubbel - Ø 18.5 cm
 Linksachter - Keramisch - enkel - Ø 15.0 cm
 Midden - Keramisch - triple - - Ø 29.0 cm
 Rechtsachter - Keramisch - enkel - Ø 20.0 cm
 Rechtsvoor - Keramisch - enkel - Ø 15.0 cm

Automatisch uitschakelen i.g.v. oververhitting	Ja	Restwarmte indicator	Ja
Automatisch uitschakelen i.g.v. overkoken	Ja		

Elektrische aansluiting

Nominale aansluitwaarde	9100 W	Type of electric cable supplied	No
Stroom	26 A	Frequentie	50/60 Hz
Spanning (V)	220-240 V	Lengte voedingskabel	150 cm
Spanning 2 (V)	380-415 V	Aansluiting	6 polig
Type stroomkabel	Eenfasig	Stekker	Nee
Type stroomkabel	Yes, Double and Three Phase		

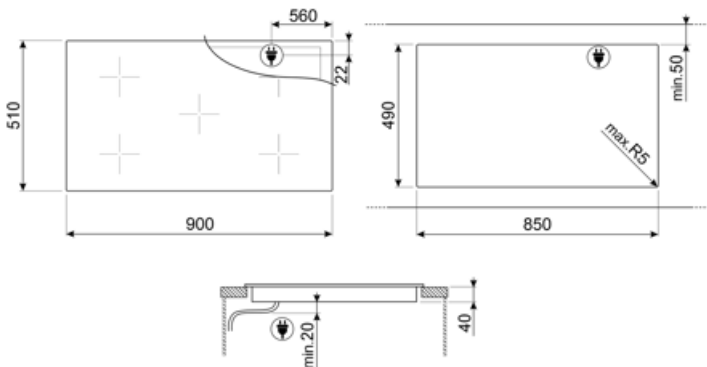













Compatible Accessories



SCRP

Schraper voor inductie- en vitrokeramische kookplaten

Symbols glossary

	Power booster: option allows the zone to work at full power when very intense cooking is necessary.		Ultra-low profile: Installation of product with flat edge - height of 1 mm.
	Sommige modellen zijn voorzien van een functie om het programma/de cyclus te blokkeren zodat het niet per ongeluk kan aangepast worden.		ECO-logic: option allows you to restrict the power limit of the appliance real energy saving.
	This function allows you to keep cooked food warm without burner it		Overheat protection: The safety system that automatically turns off the hob in case of overheating of the control unit.
	Glass ceramic: The base of the hob is made glass ceramic. Heating is performed by the heating elements Hi-Light.		Overfill protection: The special overflow protection shuts down the stove in the presence of overflow of liquids.
	Quick Start function: the chosen temperature is reached faster. The heating element works at maximum power until the right temperature is reached.		Indication of residual heat: After the glass ceramic hob is switched off the residual heat indicator shows which of the heating zones still remains hot. When the temperature drops below 60 ° C, the indicator goes out.
	Time elapsed: shows how long the cooking zone has been in use.		Timer: All ceramic hobs have a timer which automatically ends cooking after a preset time.
	Compact Slider intuitive and easy to use		