

SF4101MN1

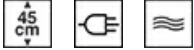

Category	45cm compact
Product Family	Oven
Power supply	Electric
Heat source	Electric
Cooking method	Microwave with grill
EAN code	8017709287191



Aesthetics

Aesthetics	Linea	Serigraphy colour	Grey
Colour	Black	Serigraphy type	Symbols
Design	Flat	Door	Full glass
Material	Glass	Handle	Linea
Type of steel	Brushed	Handle Colour	Chromed
Glass Type	Clear1	Logo	Silk screen

Controls



Display name	CompactScreen	No. of controls	2
Display technology	LCD	Control knobs	Linea
Control setting	Control knobs		

Programs / Functions

No. of cooking functions 4
 Traditional cooking functions



Microwave functions

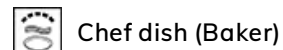

Other functions



Defrost by time

Options



Time-setting options	Delay start and automatic end cooking
Minute minder	Yes
Timer	1
Controls Lock / Child Safety	Yes

Other options	Keep warm
Showroom demo option	Yes
Rapid pre-heating	Yes

Technical Features



Minimum Temperature	50 °C
Maximum temperature	250 °C
Shelf positions	3
Shelves type	Metal racks
Tilting grill	Yes
No. of lights	1
Light type	Halogen
Light power	40 W
Light when door is opened	Yes
Grill element - power	1500 W
Heating suspended when door is opened	Yes

Door opening type	Standard opening
Door	Temperate door
Total no. of door glasses	3
Microwave stops when door is opened	Yes
Safety Thermostat	Yes
Cooling system	Tangential
Cooling duct	Single
Usable cavity space dimensions (HxWxD)	212x462x407 mm
Temperature control	Electronic
Cavity material	Easy clean enamel
Microwave screen protection	Yes

Performance / Energy Label



Net volume of the cavity	40 litres
Number of cavities	1

Microwave effective power	1000 W
----------------------------------	--------

Accessories Included

Chrome shelf	1
---------------------	---

Electrical Connection

Voltage	220-240 V
Current	15 A

Frequency (Hz)	50 Hz
-----------------------	-------

Nominal power (W)

3300 W

Power supply cable
length

115 cm

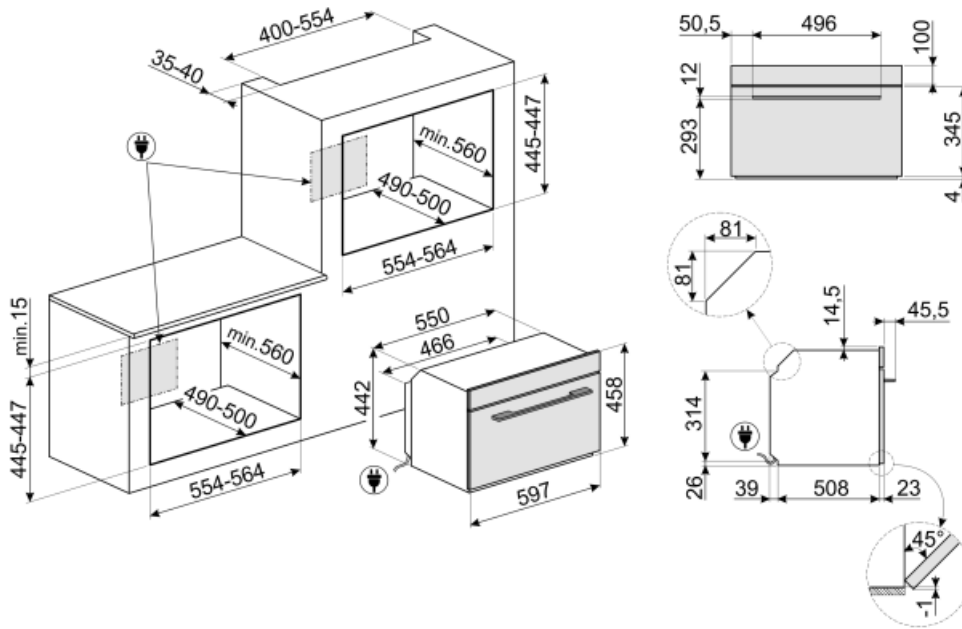

Not included accessories

GTP

Partially extractable telescopic guides (1 level) Extraction: 300 mm Material: Stainless steel AISI 430 polished



KIT130S

Trim kit for 45 cm Linea ovens



GT1P-2

Partially extractable telescopic guides (1 level) for ovens with metal frames. Length: 355.5 mm, extraction: 285 mm. Material: Stainless steel AISI 430 polished.



GTT

Totally extractable telescopic guides (1 level) Extraction: 433 mm Material: Stainless steel AISI 430 polished



PR3845X

Antifingerprint stainless steel. Cover for furniture in column installation of more ovens



BN620-1

Enamelled tray, 20mm deep



PALPZ

Pizza shovel with fold away handle width: 315mm length : 325mm























BN640

Enamelled tray, 40mm deep



Symbols glossary

 <p>Child lock: some models are fitted with a device to lock the programme/cycle so it cannot be accidentally changed.</p>	 <p>Microwave energy shortens cooking times dramatically and produces energy savings.</p>
 <p>Air cooling system: to ensure a safe surface temperatures.</p>	 <p>Defrost by time: with this function the time of thawing of foods are determined automatically.</p>
 <p>Triple glazed doors: Number of glazed doors.</p>	 <p>...</p>
 <p>Electric</p>	 <p>Enamel interior: The enamel interior of all Smeg ovens have a special antacid lining which helps keep the interior clean by reducing the amount of cooking grease adhering to it.</p>
 <p>Crisper: The simultaneous operation of the microwave, grill and crisper plate (once pre-heated) allows the food to go crispy and golden, ideal for cooking Pizza etc</p>	 <p>Grill element: Using of grill gives excellent results when cooking meat of medium and small portions, especially when combined with a rotisserie (where possible). Also ideal for cooking sausages and bacon.</p>
 <p>Microwave: Penetrating straight into the food, microwaves cook very quickly and with considerable energy savings. Suitable for cooking without fat, they are also able to thaw and heat food without altering its original appearance and aroma. The microwave function can also be combined with conventional functions with all the resulting advantages. Ideal for all types of food.</p>	 <p>Microwave + grill element: The use of the grill results in a perfect browning of the surface of the food. The action of microwaves allows instead of cooking in a short time the internal part of the food.</p>
 <p>Compact appliances with a height of 45 cm - perfect solution to meet the functional requirements of kitchen sets of small height. Available in several types and in different styles.</p>	 <p>Keep warm: This function allows you to keep precooked foods warm.</p>
 <p>Side lights: Two opposing side lights increase visibility inside the oven.</p>	 <p>Rapid preheat: The rapid preheat function can be used to reach the selected temperature in just a few minutes.</p>
 <p>The oven cavity has 3 different cooking levels.</p>	 <p>Electronic control: Allows you to maintain temperature inside the oven with the precision 2-3 ° C. This enables to cook meals that are very sensitive to temperature changes, such as cakes, souffles, puddings.</p>
 <p>Tilting grill: the tilting grill can be easily unhooked to move the heating element and clean the roof of the appliance in one simple step.</p>	 <p>The capacity indicates the amount of usable space in the oven cavity in litres.</p>