

SF4101MS1



Categorie	45 cm
Product familie	Oven
Stroomvoorziening	Elektrisch
Warmtebron	Elektriciteit
Bereidingswijze	Microgolf met grill
EAN-code	8017709282219



Design

Design	Linea	Kleur serigrafie	Wit
Kleur	Zilver	Type zeefdruk	Symbolen
Design	Plat	Deur	Geheel glas
Materiaal	Glas	Handvat	Linea
Type roestvrijstaal	Geborsteld inox	Kleur handvat	Chroom
Type glas	Stopsol	Logo	Geëts

Bediening



Display	CompactScreen	Aantal bedieningsknoppen	2
Display	LCD	Bedieningsknoppen	Linea
Bediening	Bedieningsknoppen		

Programma's / Functies

Aantal kookfuncties	4
Traditionele bereidingsfuncties	



Bereidingsfuncties met microgolven

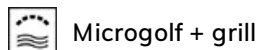

Overige functies

 Ontdooien op tijd

Opties



Tijdsinstelling	Automatische in- en uitschakeling	Andere opties	Warmhoudfunctie
Timer	Ja	Showroom demo optie	Ja
Timer	1	Snel voorverwarmen	Ja
Kinderbeveiliging	Ja		

Technische specificaties



Minimum temperatuur	50 °C	Opening deur	Standaard opening
Maximum temperatuur	250 °C	Deur	Temperatuur gecontroleerde deur
Aantal kookniveaus	3	Totaal aantal ruiten	3
Type rekken	Metalen zijsteunen	Automatische uitschakeling microgolf bij openen deur	Ja
Kantelbare grill	Ja	Veiligheidsthermostaat	Ja
Aantal lampen	1	Koelsysteem	Mantelkoeling
Type lamp	Halogeen	Koelleiding	Enkel
Vermogen lamp	40 W	Afmetingen bruikbare interne ovenruimte (hxbxd)	212x462x407 mm
Verlichting bij opening deur	Ja	Temperatuurcontrole	Elektronisch
Grill - vermogen	1500 W	Materiaal ovenruimte	Ever Clean emaille
Warmte onderbroken bij openen deur	Ja	Veiligheidsscherm microgolfdeur	Ja

Prestaties / energielabel



Netto volume	40 l	Effectief vermogen microgolf	1000 W
Aantal ovens	1		

Meegeleverde accessoires

Ovenrooster met stop 1

Elektrische aansluiting

Spanning 220-240 V

Frequentie 50 Hz

Stroom 15 A
Nominale aansluitwaarde 3300 W

Lengte voedingskabel 115 cm

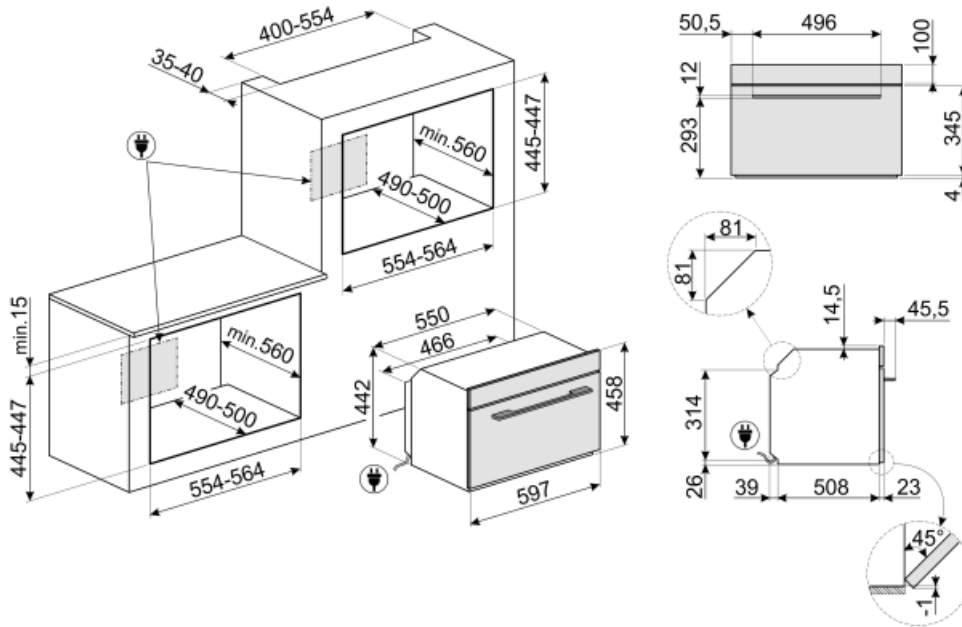

Not included accessories

GTP

Partially extractable telescopic guides (1 level), suitable for traditional ovens. Made in stainless steel, they guarantee stability and facilitate the smooth extraction of the trays.



KIT130S

Trim kit for 45 cm Linea ovens



GT1P-2

Partially extractable telescopic guides (1 level) for ovens with metal frames. Length: 355.5 mm, extraction: 285 mm. Material: Stainless steel AISI 430 polished.



GTT

Volledig uitschuifbare telescopische rails (1 niveau) voor traditionele ovens (SF-).



PR3845X

Inox profiel voor installatie ovens in kolom



BN620-1

Enamelled tray suitable for 45cm and 60cm ovens. Depth 20 mm. Perfect for a wide range of savoury and sweet baking.



PALPZ

Pizzapallet inox met plooibaar handvat, 315x325 mm





















BN640

Enamelled tray suitable for 45cm and 60cm ovens. Depth 540 mm. Perfect for cooking and roasting meat and fish in sauces. Also ideal for experimenting with lighter and crunchy side dishes



Symbols glossary (TT)

 <p>Sommige modellen zijn voorzien van een functie om het programma/de cyclus te blokkeren zodat het niet per ongeluk kan aangepast worden.</p>	 <p>Microwave energy shortens cooking times dramatically and produces energy savings.</p>
 <p>Air cooling system: to ensure a safe surface temperatures.</p>	 <p>Defrost by time: Manual defrost function. At the end of the set duration, the function stops.</p>
 <p>COMPACTscreen display + bedieningsknoppen</p>	 <p>Triple glazed doors: Number of glazed doors.</p>
 <p>Elektrische aansluiting</p>	 <p>Ever Clean Enamel: Ever Clean enamel is applied electrostatically, corner to corner and edge to edge to prevent cracking or cracks over time. It is a particular pyrolytic enamel, resistant to acids which, in addition to being pleasantly bright, promotes greater cleaning of the oven walls, thanks to its lower porosity. It is baked at over 850 ° C and slowly polymerized at a scientifically determined rate to ensure uniform depth and strength Ever Clean enamel creates an impeccable finish both on the inside of the oven and on the trays, making the surfaces of the oven incredibly easy to maintain over time as it reduces the adhesion of fat during cooking</p>
 <p>Crisper: The simultaneous operation of the microwave, grill and crisper plate (once pre-heated) allows the food to go crispy and golden, ideal for cooking Pizza etc</p>	 <p>Grill: Very intense heat coming only from above from a double heating element. The fan is not active. Provides excellent grilling and gratinating results. Used at the end of cooking, it gives a uniform browning to dishes.</p>
 <p>Microwave: Penetrating straight into the food, microwaves cook very quickly and with considerable energy savings. Suitable for cooking without fat, they are also able to thaw and heat food without altering its original appearance and aroma. The microwave function can also be combined with conventional functions with all the resulting advantages. Ideal for all types of food.</p>	 <p>Microwave + grill element: The use of the grill results in a perfect browning of the surface of the food. The action of microwaves allows instead of cooking in a short time the internal part of the food.</p>
 <p>Compacte toestellen met een hoogte van 45 cm - perfecte oplossing om te voldoen aan de functionele eisen van keukensets met een kleine hoogte. Verkrijgbaar in verschillende soorten en in verschillende stijlen.</p>	 <p>Met deze functie kan u bereidingen warmhouden zodat het eten niet meteen afkoelt</p>
 <p>Side lights: Two opposing side lights increase visibility inside the oven.</p>	 <p>Rapid preheating: cooking is preceded by the preheating phase which allows the cooking compartment to reach the set temperature. This option reduces the time by up to 50%.</p>
 <p>The oven cavity has 3 different cooking levels.</p>	 <p>Electronic control: Allows you to maintain temperature inside the oven with the precision 2-3 ° C. This enables to cook meals that are very sensitive to temperature changes, such as cakes, souffles, puddings.</p>



Tilting grill: the tilting grill can be easily unhooked to move the heating element and clean the roof of the appliance in one simple step.



The capacity indicates the amount of usable space in the oven cavity in litres.