

# SF4104WMCN



Category	45cm compact
Product Family	Oven
Power supply	Electric
Heat source	ELECTRICITY
Cooking method	Combi Microwave
Cleaning system	Vapour Clean
EAN code	8017709275914



## Aesthetics

Aesthetic	Linea	Serigraphy type	Symbols
Colour	Black	Door	Full glass
Design	Flat	Handle	Linea
Material	Glass	Handle Colour	Black
Glass Type	Clear	Logo	Silk screen
Serigraphy colour	Grey		

## Controls



Display name	VivoScreen	No. of display languages	11
Display technology	TFT	Display languages	Italiano, English (UK), Français (FR), Nederlands, Español (ES), Português (PT), Svenska, Русский, Deutsch (DE), Dansk, Polski
Control setting	Full touch		

## Programs / Functions

No. of cooking functions	15
Automatic programmes	56
Customisable recipes	64

### Traditional cooking functions

Static	Fan assisted	Circulaire
Turbo	Eco	Large grill
Fan grill (large)	Base	Circulaire + bottom
Pizza		

### Microwave functions

Microwave	Fan assisted	Circulaire
Microwave + grill	Warming and re-generation	

### Other functions

Defrost by time	Defrost by weight	Proving
Keep warm	Plate rack/warmer	Sabbath

### Cleaning functions

Vapour Clean
--------------

## Options



<b>Time-setting options</b>	Delay start and automatic end cooking	<b>Showroom demo option</b>	Yes
<b>Minute minder</b>	Yes	<b>Demo-tutorial mode</b>	Yes
<b>Timer</b>	3	<b>Touch guide</b>	Yes
<b>Controls Lock / Child Safety</b>	Yes	<b>Chronology</b>	Yes, the last 10 functions utilised
<b>Other options</b>	Keep warm, Eco light, Quick start, Language setting, Digital clock display, Brightness, ECO-logic, Tones, Tones volume	<b>Rapid pre-heating</b>	Yes
<b>Smart cooking</b>	Yes	<b>Instant GO</b>	Yes

## Technical Features



<b>Minimum Temperature</b>	30 °C	<b>Door opening type</b>	Standard opening
<b>Maximum temperature</b>	250 °C	<b>Door</b>	Temperate door
<b>No. of shelves</b>	3		

<b>No. of lights</b>	2	<b>Total no. of door glasses</b>	3
<b>Light type</b>	Halogen	<b>Microwave stops when door is opened</b>	Yes
<b>Light Power</b>	40 W	<b>Soft Close hinges</b>	Yes
<b>Light when door is opened</b>	Yes	<b>Cooling system</b>	Tangential
<b>Lower heating element power</b>	1000 W	<b>Cooling duct</b>	Single
<b>Grill element - power</b>	2000 W	<b>Usable cavity space dimensions (HxWxD)</b>	212x462x407 mm
<b>Circular heating element - Power</b>	1400 W	<b>Temperature control</b>	Electronic
<b>Heating suspended when door is opened</b>	Yes	<b>Cavity material</b>	Ever clean Enamel
		<b>Microwave screen protection</b>	Yes

## Performance / Energy Label



<b>Net volume of the cavity</b>	40 l	<b>Microwave effective power</b>	1000 W
<b>Number of cavities</b>	1		

## Accessories Included



<b>Rack with back and side stop</b>	1	<b>Glass tray</b>	1
<b>Insert gird</b>	1	<b>Telescopic Guide rails, partial Extraction</b>	1

## Electrical Connection

<b>Voltage</b>	220-240 V	<b>Frequency (Hz)</b>	50 Hz
<b>Current</b>	14 A	<b>Power supply cable length</b>	115 cm
<b>Nominal power</b>	3100 W		

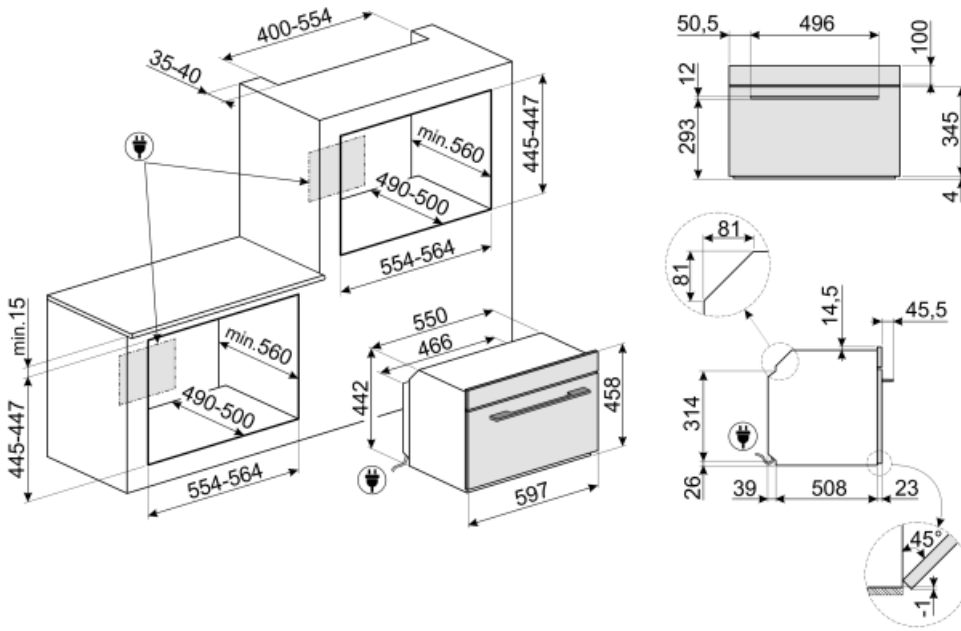

---

## Not included accessories

---

### GTP

\*\*Partially extractable telescopic guides (1 level)\*\* Extraction: 300 mm Material: Stainless steel AISI 430 polished



### BN620-1

Enamelled tray, 20mm deep



### GTT

\*\*Totally extractable telescopic guides (1 level)\*\* Extraction: 433 mm Material: Stainless steel AISI 430 polished



### PR3845X

Antifingerprint stainless steel. Cover for furniture in column installation of more ovens



### PALPZ

Pizza shovel with fold away handle width: 315mm length : 325mm







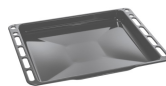



































### BN640





Enamelled tray, 40mm deep



## Symbols glossary (TT)

 <p>Child lock: some models are fitted with a device to lock the programme/cycle so it cannot be accidentally changed.</p>	 <p>Combination microwave: This oven allows to combine two different ways of cooking (Traditional with microwaves). Combined ovens increase cooking opportunities, while providing maximum flexibility of household appliances.</p>
 <p>Air cooling system: to ensure a safe surface temperatures.</p>	 <p>Defrost by time: with this function the time of thawing of foods are determined automatically.</p>
 <p>Defrost by weight: With this function the defrosting time is determined</p>	 <p>Triple glazed doors: Number of glazed doors.</p>
 <p>Automatic lighting switches off: for greater energy savings, the lighting switches off automatically after one minute from the start of cooking.</p>	 <p>ECO-logic: option allows you to restrict the power limit of the appliance real energy saving.</p>
 <p>Electric</p>	 <p>Enamel interior: The enamel interior of all Smeg ovens have a special antacid lining which helps keep the interior clean by reducing the amount of cooking grease adhering to it.</p>
 <p>Fan with upper and lower elements: The elements combined with the fan aim to provide more uniform heat, a similar method to conventional cooking, so pre-heat is required. Most suitable for items requiring slow cooking methods.</p>	 <p>Upper and lower element only: a traditional cooking method best suited for single items located in the centre of the oven. the top pf the oven will always be hottest. Ideal for roast, fruit cakes, bread etc.</p>
 <p>Lower heating element only: This function is ideal for foods that require extra base temperature without browning, e.g. pastry dishes, pizza. Also suitable for slow cooking of stews and casseroles.</p>	 <p>Circulaire with lower element: The addition of the lower element adds extra heat at the base for food which requires extra cooking.</p>
 <p>Circulaire: The combination of the fan and circular element around it gives a hot air cooking method. This provides many benefits including no preheat if cook time is more than 20 minutes, no flavour transfer when cooking different foods at the same time, less energy, and shorter cook times. Good for all types of food.</p>	 <p>ECO: The combination of the grill, fan and lower element is particularly suitable for cooking small quantities of food.</p>
 <p>Grill element: Using of grill gives excellent results when cooking meat of medium and small portions, especially when combined with a rotisserie (where possible). Also ideal for cooking sausages and bacon.</p>	 <p>Fan with grill element: The fan reduces the fierce heat from the grill, providing an excellent method of grilling various foods, chops, steaks, sausages etc. giving even browning and heat distribution, without drying out the food. The top two levels recommended for use, and the lower part of the oven can be used to keep items warm at the same time, an excellent facility when cooking a grilled breakfast. Half grill (centre portion only) is ideal for small quantities of food.</p>

- |  |   |
|--|---|
|  <p>Microwave: Penetrating straight into the food, microwaves cook very quickly and with considerable energy savings. Suitable for cooking without fat, they are also able to thaw and heat food without altering its original appearance and aroma. The microwave function can also be combined with conventional functions with all the resulting advantages. Ideal for all types of food.</p> |  <p>Cooking with the simultaneous use of the heating element in combination with fan and microwave supply.</p>   |
|  <p>Microwave + grill element: The use of the grill results in a perfect browning of the surface of the food. The action of microwaves allows instead of cooking in a short time the internal part of the food.</p>  |  <p>Fan combined with traditional cooking, where heat is generated from above and below, provides uniform heat. Adding the microwave function allows the same cooking results in less time.</p>                            |
|  <p>This function can reheat precooked dishes, without becoming dry or hard.</p>   |  <p>Pizza function: The simultaneous operation of three elements ensures an optimum cooking facility when used with the Smeg pizza stone.</p>  |
|  <p>Circulaire with upper and lower elements: The use of the fan with both elements allows food to be cooked quickly and effectively, ideal for large joints that require thorough cooking. It offers a similar result to rotisserie, moving the heat around the food, instead of moving the food itself, enabling any size or shape to be cooked.</p>   |  <p>Compact appliances with a height of 45 cm - perfect solution to meet the functional requirements of kitchen sets of small height. Available in several types and in different styles.</p>                              |
|  <p>KEEP_WARM_72dpi</p>  |  <p>Side lights: Two opposing side lights increase visibility inside the oven.</p>   |
|  <p>Warming up: An option for dish warming and keeping the prepared meals hot.</p>   |  <p>Air at 40°C provides the perfect environment for proving yeast type dough mixes. Simply select the function and place dough in the cavity for allotted</p>   |
|  <p>Rapid preheat: The rapid preheat function can be used to reach the selected temperature in just a few minutes.</p>   |  <p>Sabbath: This function allows you to cook food during the Sabbath, the Holiday of rest in the Jewish religion, respecting the precepts. The oven works</p>   |
|  <p>Touch guide: By holding down any symbol for 3 seconds you can get information on its function</p>  |  <p>The oven cavity has 3 different cooking levels.</p>  |
|  <p>Smart Cooking System: for the perfect cooking it is simply necessary choosing the kind and the weight of food and the cooking temperature: any other setting will be established automatically.</p>  |  <p>Soft close: all models are equipped with advanced function of smooth closing of the door, which allows the device to close smoothly and quietly.</p>   |
|  <p>Telescopic rails: allow you to pull out the dish and check it without having to remove it from the oven entirely.</p>  |  <p>Electronic control: Allows you to maintain temperature inside the oven with the precision 2-3 ° C. This enables to cook meals that are very sensitive to temperature changes, such as cakes, souffles, puddings.</p> |
|  <p>Tilting grill: the tilting grill can be easily unhooked to move the heating element and clean the roof of the appliance in one simple step.</p>  |  <p>Touch controls: Easy to use touch controls allow the appliance to be programmed at the touch of a button.</p>  |

- 
- |  |   |   |   |
|--|---|---|---|
|  | Vapour Clean: a simple cleaning function using steam to loosen deposits in the oven cavity. |  | The capacity indicates the amount of usable space in the oven cavity in litres. |
|  | ...   |  | ...   |
|  | ...   |   |   |