

SF4301MCX

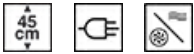

Category	45cm compact
Product Family	Oven
Power supply	Electric
Heat source	Electric
Cooking method	Combi Microwave
EAN code	8017709282226



Aesthetics

Aesthetics	Classic	Serigraphy colour	Black
Colour	Stainless steel	Serigraphy type	Symbols
Finishing	Fingerproof	Door	With 2 horizontal strips
Design	Flat	Handle	Classic
Material	Stainless steel	Handle Colour	Stainless steel
Type of steel	Brushed	Logo	Embossed
Glass Type	Eclipse		

Controls



Display name	CompactScreen	No. of controls	2
Display technology	LCD	Control knobs	Classic
Control setting	Control knobs		

Programs / Functions

No. of cooking functions	10
--------------------------	----

Traditional cooking functions



Static



Fan assisted



Cicalaire



Turbo (circular + bottom + upper + fan)



ECO



Large grill



Pizza

Microwave functions



Microwave



Microwave + bottom + top + fan



Microwave + circular + fan



Microwave + grill

Other functions



Defrost by time

Options



Time-setting options	Delay start and automatic end cooking
Minute minder	Yes
Timer	1
Controls Lock / Child Safety	Yes

Other options	Keep warm
Showroom demo option	Yes
Rapid pre-heating	Yes

Technical Features



Minimum Temperature	30 °C	Heating suspended when door is opened	Yes
Maximum temperature	250 °C	Door opening type	Standard opening
Shelf positions	3	Door	Temperate door
Shelves type	Metal racks	Total no. of door glasses	3
Tilting grill	Yes	Microwave stops when door is opened	Yes
No. of lights	1	Safety Thermostat	Yes
Light type	Halogen		
Light power	40 W		

Light when door is opened	Yes	Cooling system	Tangential
Lower heating element power	1000 W	Cooling duct	Single
Grill element - power	2000 W	Usable cavity space dimensions (HxWxD)	212x462x407 mm
Circular heating element - Power	1400 W	Temperature control	Electronic
		Cavity material	Easy clean enamel
		Microwave screen protection	Yes

Performance / Energy Label



Net volume of the cavity	40 litres	Microwave effective power	1000 W
Number of cavities	1		

Accessories Included

Chrome shelf	1	Glass tray	1
Grill mesh	1		

Electrical Connection

Voltage	220-240 V	Frequency (Hz)	50 Hz
Current	14 A	Power supply cable length	115 cm
Nominal power (W)	3100 W		

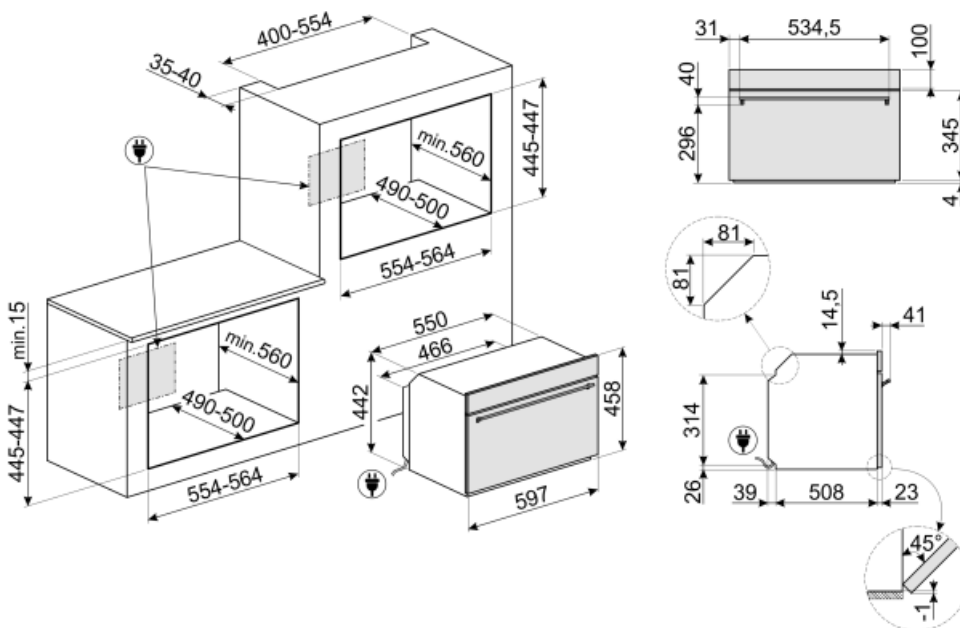

Not included accessories

GTP

Partially extractable telescopic guides (1 level) Extraction: 300 mm Material: Stainless steel AISI 430 polished



BN620-1

Enamelled tray, 20mm deep



PALPZ

Pizza shovel with fold away handle width: 315mm length : 325mm



BN640

Enamelled tray, 40mm deep



PR3845X

Antifingerprint stainless steel. Cover for furniture in column installation of more ovens



GT1P-2

Partially extractable telescopic guides (1 level) for ovens with metal frames. Length: 355.5 mm, extraction: 285 mm. Material: Stainless steel AISI 430 polished.



GTT

Totally extractable telescopic guides (1 level) Extraction: 433 mm Material: Stainless steel AISI 430 polished





























KIT330X

Trim kit for 45 cm Classica ovens



Symbols glossary

 <p>Child lock: some models are fitted with a device to lock the programme/cycle so it cannot be accidentally changed.</p>	 <p>Combination microwave: This oven allows to combine two different ways of cooking (Traditional with microwaves). Combined ovens increase cooking opportunities, while providing maximum flexibility of household appliances.</p>
 <p>Air cooling system: to ensure a safe surface temperatures.</p>	 <p>Defrost by time: with this function the time of thawing of foods are determined automatically.</p>
 <p>Triple glazed doors: Number of glazed doors.</p>	 <p>Electric</p>
 <p>Enamel interior: The enamel interior of all Smeg ovens have a special antacid lining which helps keep the interior clean by reducing the amount of cooking grease adhering to it.</p>	 <p>Fan with upper and lower elements: The elements combined with the fan aim to provide more uniform heat, a similar method to conventional cooking, so pre-heat is required. Most suitable for items requiring slow cooking methods.</p>
 <p>Upper and lower element only: a traditional cooking method best suited for single items located in the centre of the oven. the top pf the oven will always be hottest. Ideal for roast, fruit cakes, bread etc.</p>	 <p>Circulaire: The combination of the fan and circular element around it gives a hot air cooking method. This provides many benefits including no preheat if cook time is more than 20 minutes, no flavour transfer when cooking different foods at the same time, less energy, and shorter cook times. Good for all types of food.</p>
 <p>ECO: The combination of the grill, fan and lower element is particularly suitable for cooking small quantities of food.</p>	 <p>Grill element: Using of grill gives excellent results when cooking meat of medium and small portions, especially when combined with a rotisserie (where possible). Also ideal for cooking sausages and bacon.</p>
 <p>Microwave: Penetrating straight into the food, microwaves cook very quickly and with considerable energy savings. Suitable for cooking without fat, they are also able to thaw and heat food without altering its original appearance and aroma. The microwave function can also be combined with conventional functions with all the resulting advantages. Ideal for all types of food.</p>	 <p>Cooking with the simultaneous use of the heating element in combination with fan and microwave supply.</p>
 <p>Microwave + grill element: The use of the grill results in a perfect browning of the surface of the food. The action of microwaves allows instead of cooking in a short time the internal part of the food.</p>	 <p>Fan combined with traditional cooking, where heat is generated from above and below, provides uniform heat. Adding the microwave function allows the same cooking results in less time.</p>
 <p>Pizza function: The simultaneous operation of three elements ensures an optimum cooking facility when used with the Smeg pizza stone.</p>	 <p>Circulaire with upper and lower elements: The use of the fan with both elements allows food to be cooked quickly and effectively, ideal for large joints that require thorough cooking. It offers a similar result to rotisserie, moving the heat around the food, instead of moving the food itself, enabling any size or shape to be cooked.</p>

-
-  Compact appliances with a height of 45 cm - perfect solution to meet the functional requirements of kitchen sets of small height. Available in several types and in different styles.
 -  Side lights: Two opposing side lights increase visibility inside the oven.
 -  The oven cavity has 3 different cooking levels.
 -  Tilting grill: the tilting grill can be easily unhooked to move the heating element and clean the roof of the appliance in one simple step.
 -  ...
 -  Keep warm: This function allows you to keep precooked foods warm.
 -  Rapid preheat: The rapid preheat function can be used to reach the selected temperature in just a few minutes.
 -  Electronic control: Allows you to maintain temperature inside the oven with the precision 2-3 ° C. This enables to cook meals that are very sensitive to temperature changes, such as cakes, souffles, puddings.
 -  The capacity indicates the amount of usable space in the oven cavity in litres.