

SF4301MX

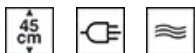

| | |
|--------------------------|---------------------|
| Categorie | 45 cm |
| Product familie | Oven |
| Stroomvoorziening | Elektrisch |
| Warmtebron | Elektriciteit |
| Bereidingswijze | Microgolf met grill |
| EAN-code | 8017709282233 |



Design

| | | | |
|----------------------------|--------------------|-------------------------|---------------------------|
| Design | Classici | Kleur serigrafie | Zwart |
| Kleur | Inox | Type zeefdruk | Symbolen |
| Afwerking | Fingerproof | Deur | Met 2 horizontale stroken |
| Design | Plat | Handvat | Classici |
| Materiaal | Inox | Kleur handvat | Inox |
| Type roestvrijstaal | Geborsteld inox | Logo | In reliëf |
| Type glas | Eclipse zwart glas | | |

Bediening



| | | | |
|----------------|---------------|---------------------------------|----------|
| Display | CompactScreen | Aantal bedieningsknoppen | 2 |
| Display | LCD | Bedieningsknoppen | Classici |

Programma's / Functies

| | |
|--|---|
| Aantal kookfuncties | 4 |
| Traditionele bereidingsfuncties | |



Grote grill

Bereidingsfuncties met microgolven



Microgolfoven



Microgolf + grill



Crisp

Overige functies

 Ontdooien op tijd

Opties



| | | | |
|--------------------------|-----------------------------------|----------------------------|-----------------|
| Tijdsinstelling | Automatische in- en uitschakeling | Andere opties | Warmhoudfunctie |
| Timer | Ja | Showroom demo optie | Ja |
| Timer | 1 | Snel voorverwarmen | Ja |
| Kinderbeveiliging | Ja | | |

Technische specificaties



| | | | |
|---|--------------------|---|---------------------------------|
| Minimum temperatuur | 50 °C | Opening deur | Standaard opening |
| Maximum temperatuur | 250 °C | Deur | Temperatuur gecontroleerde deur |
| Aantal kookniveaus | 3 | Totaal aantal ruiten | 3 |
| Type rekken | Metalen zijsteunen | Automatische uitschakeling microgolf bij openen deur | Ja |
| Kantelbare grill | Ja | Veiligheidsthermostaat | Ja |
| Aantal lampen | 1 | Koelsysteem | Mantelkoeling |
| Type lamp | Halogeen | Koelleiding | Enkel |
| Vermogen lamp | 40 W | Afmetingen bruikbare interne ovenruimte (hxbxd) | 212x462x407 mm |
| Verlichting bij opening deur | Ja | Temperatuurcontrole | Elektronisch |
| Grill - vermogen | 1500 W | Materiaal ovenruimte | Ever Clean emaille |
| Warmte onderbroken bij openen deur | Ja | Veiligheidsscherm microgolfdeur | Ja |

Prestaties / energielabel



| | | | |
|---------------------|------|-------------------------------------|--------|
| Netto volume | 40 l | Effectief vermogen microgolf | 1000 W |
| Aantal ovens | 1 | | |

Meegeleverde accessoires

Ovenrooster met stop 1

Elektrische aansluiting

Spanning 220-240 V

Frequentie 50 Hz

Stroom 15 A

Lengte voedingskabel 115 cm

Nominale aansluitwaarde

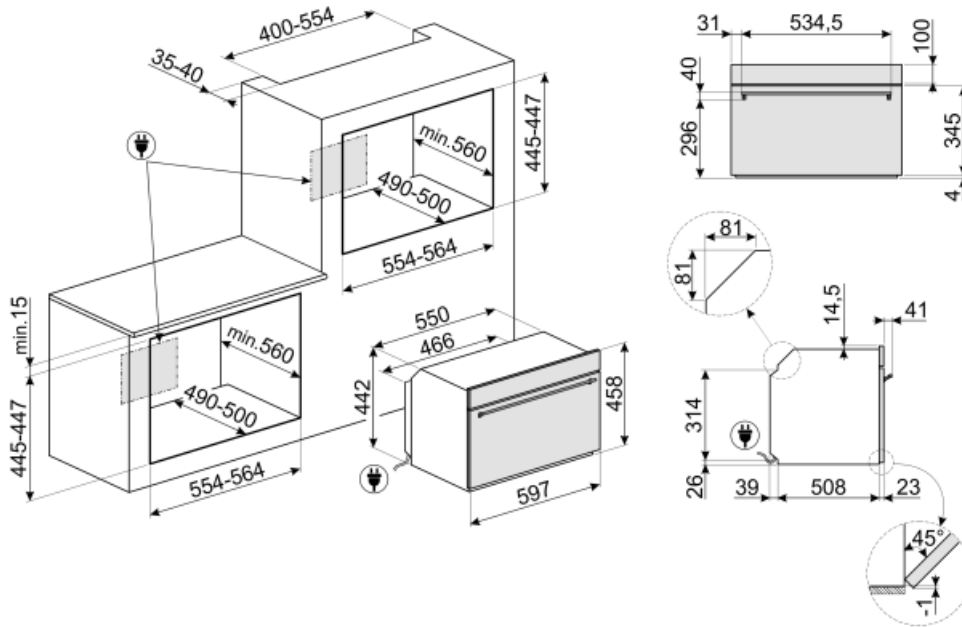

Not included accessories

GTP

Partially extractable telescopic guides (1 level), suitable for traditional ovens. Made in stainless steel, they guarantee stability and facilitate the smooth extraction of the trays.



BN620-1

Enamelled tray suitable for 45cm and 60cm ovens. Depth 20 mm. Perfect for a wide range of savoury and sweet baking.



PALPZ

Pizzapallet inox met ploibaar handvat, 315x325 mm



BN640

Enamelled tray suitable for 45cm and 60cm ovens. Depth 540 mm. Perfect for cooking and roasting meat and fish in sauces. Also ideal for experimenting with lighter and crunchy side dishes



PR3845X

Inox profiel voor installatie ovens in kolom



GT1P-2

Partially extractable telescopic guides (1 level) for ovens with metal frames. Length: 355.5 mm, extraction: 285 mm. Material: Stainless steel AISI 430 polished.



GTT

Volledig uitschuifbare telescopische rails (1 niveau) voor traditionele ovens (SF-).























KIT330X

Trim kit for 45 cm Classica ovens



Symbols glossary (TT)

| | |
|--|---|
|  <p>Sommige modellen zijn voorzien van een functie om het programma/de cyclus te blokkeren zodat het niet per ongeluk kan aangepast worden.</p> |  <p>Microwave energy shortens cooking times dramatically and produces energy savings.</p> |
|  <p>Air cooling system: to ensure a safe surface temperatures.</p> |  <p>Defrost by time: Manual defrost function. At the end of the set duration, the function stops.</p> |
|  <p>Triple glazed doors: Number of glazed doors.</p> |  <p>Elektrische aansluiting</p> |
|  <p>Ever Clean Enamel: Ever Clean enamel is applied electrostatically, corner to corner and edge to edge to prevent cracking or cracks over time. It is a particular pyrolytic enamel, resistant to acids which, in addition to being pleasantly bright, promotes greater cleaning of the oven walls, thanks to its lower porosity. It is baked at over 850 ° C and slowly polymerized at a scientifically determined rate to ensure uniform depth and strength Ever Clean enamel creates an impeccable finish both on the inside of the oven and on the trays, making the surfaces of the oven incredibly easy to maintain over time as it reduces the adhesion of fat during cooking</p> |  <p>Crisper: The simultaneous operation of the microwave, grill and crisper plate (once pre-heated) allows the food to go crispy and golden, ideal for cooking Pizza etc</p> |
|  <p>Grill: Very intense heat coming only from above from a double heating element. The fan is not active. Provides excellent grilling and gratinating results. Used at the end of cooking, it gives a uniform browning to dishes.</p> |  <p>Microwave: Penetrating straight into the food, microwaves cook very quickly and with considerable energy savings. Suitable for cooking without fat, they are also able to thaw and heat food without altering its original appearance and aroma. The microwave function can also be combined with conventional functions with all the resulting advantages. Ideal for all types of food.</p> |
|  <p>Microwave + grill element: The use of the grill results in a perfect browning of the surface of the food. The action of microwaves allows instead of cooking in a short time the internal part of the food.</p> |  <p>Compacte toestellen met een hoogte van 45 cm - perfecte oplossing om te voldoen aan de functionele eisen van keukensets met een kleine hoogte. Verkrijgbaar in verschillende soorten en in verschillende stijlen.</p> |
|  <p>Met deze functie kan u bereidingen warmhouden zodat het eten niet meteen afkoelt</p> |  <p>Side lights: Two opposing side lights increase visibility inside the oven.</p> |
|  <p>Rapid preheating: cooking is preceded by the preheating phase which allows the cooking compartment to reach the set temperature. This option reduces the time by up to 50%.</p> |  <p>The oven cavity has 3 different cooking levels.</p> |
|  <p>Electronic control: Allows you to maintain temperature inside the oven with the precision 2-3 ° C. This enables to cook meals that are very sensitive to temperature changes, such as cakes, souffles, puddings.</p> |  <p>Tilting grill: the tilting grill can be easily unhooked to move the heating element and clean the roof of the appliance in one simple step.</p> |
|  <p>The capacity indicates the amount of usable space in the oven cavity in litres.</p> |  <p>COMPACTscreen display + bedieningsknoppen</p> |