

# SF4390MCX



Category	45cm compact
Product Family	Oven
Power supply	Electric
Heat source	Electric
Cooking method	Combi Microwave
Cleaning system	Vapor Clean
EAN code	8017709191443



## Aesthetics

Aesthetics	Classic	Serigraphy type	Symbols
Colour	Stainless steel	Door	With 2 horizontal strips
Finishing	Fingerproof	Handle	Classic
Design	Flat	Handle Colour	Stainless steel
Material	Stainless steel	Logo	Embossed
Type of steel	Brushed	Control knobs	Classic
Glass Type	Eclipse	Controls colour	Steel effect
Serigraphy colour	Black		

## Controls

Display technology	LCD	No. of controls	2
Control setting	Control knobs		

## Programs / Functions

No. of cooking functions	13
Automatic programmes	20

### Traditional cooking functions



Static



Fan assisted



Circulaire



Turbo (circulaire + bottom + upper + fan)



ECO



Large grill



Fan grill (large)



Fan assisted base

### Microwave functions



Microwave



Microwave + bottom + top + fan



Microwave + circulaire + fan



Microwave + grill



Warming and re-generation

### Other functions



Defrost by time



Defrost by weight



Proving



Sabbath

### Cleaning functions



Vapor Clean

## Options



**Time-setting options**

Delay start and automatic end cooking

**Other options**

Keep warm, Eco light, Quick start

Minute minder

Yes

**Showroom demo option**

Yes

Controls Lock / Child Safety

Yes

**Rapid pre-heating**

Yes

## Technical Features



**Minimum Temperature**

30 °C

**Door**

Temperate door

**Maximum temperature**

250 °C

**Total no. of door glasses**

3

**Shelf positions**

3

<b>No. of lights</b>	2	<b>Microwave stops when door is opened</b>	Yes
<b>Light type</b>	Halogen	<b>Soft Close hinges</b>	Yes
<b>Light power</b>	40 W	<b>Cooling system</b>	Tangential
<b>Light when door is opened</b>	Yes	<b>Cooling duct</b>	Single
<b>Lower heating element power</b>	1000 W	<b>Usable cavity space dimensions (HxWxD)</b>	212x462x407 mm
<b>Grill element - power</b>	2000 W	<b>Temperature control</b>	Electronic
<b>Circular heating element - Power</b>	1400 W	<b>Cavity material</b>	Easy clean enamel
<b>Heating suspended when door is opened</b>	Yes	<b>Microwave screen protection</b>	Yes

## Performance / Energy Label



<b>Net volume of the cavity</b>	40 litres	<b>Microwave effective power</b>	1000 W
<b>Number of cavities</b>	1		

## Accessories Included

<b>Chrome shelf</b>	1	<b>Glass tray</b>	1
<b>Grill mesh</b>	1		

## Electrical Connection

<b>Voltage</b>	220-240 V	<b>Frequency (Hz)</b>	50 Hz
<b>Current</b>	14 A	<b>Power supply cable length</b>	150 cm
<b>Nominal power (W)</b>	3100 W		

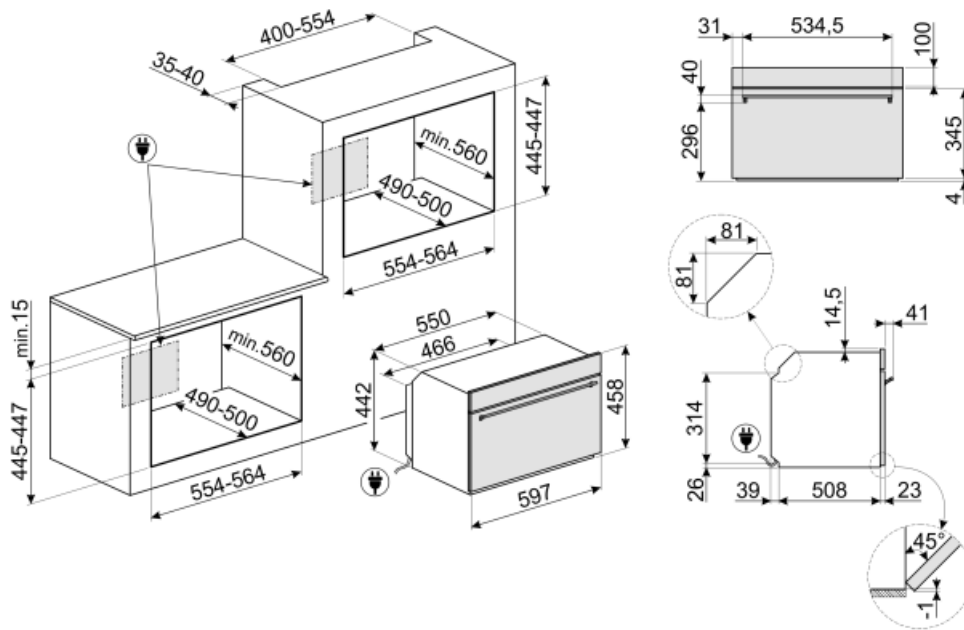

---

## Not included accessories

---

### GTP

\*\*Partially extractable telescopic guides (1 level)\*\* Extraction: 300 mm Material: Stainless steel AISI 430 polished



### BN620-1

Enamelled tray, 20mm deep



### GTT

\*\*Totally extractable telescopic guides (1 level)\*\* Extraction: 433 mm Material: Stainless steel AISI 430 polished



### KIT330X

Trim kit for 45 cm Classica ovens



### PR3845X

Antifingerprint stainless steel. Cover for furniture in column installation of more ovens



### PALPZ

Pizza shovel with fold away handle width: 315mm length : 325mm







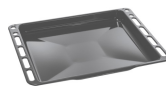





























### BN640

Enamelled tray, 40mm deep



## Symbols glossary

 <p>Child lock: some models are fitted with a device to lock the programme/cycle so it cannot be accidentally changed.</p>	 <p>Combination microwave: This oven allows to combine two different ways of cooking (Traditional with microwaves). Combined ovens increase cooking opportunities, while providing maximum flexibility of household appliances.</p>
 <p>Air cooling system: to ensure a safe surface temperatures.</p>	 <p>Defrost by time: with this function the time of thawing of foods are determined automatically.</p>
 <p>Defrost by weight: With this function the defrosting time is determined</p>	 <p>Triple glazed doors: Number of glazed doors.</p>
 <p>Automatic lighting switches off: for greater energy savings, the lighting switches off automatically after one minute from the start of cooking.</p>	 <p>Electric</p>
 <p>Enamel interior: The enamel interior of all Smeg ovens have a special antacid lining which helps keep the interior clean by reducing the amount of cooking grease adhering to it.</p>	 <p>Fan assisted base: the mix of fan and lower heating element alone allows to finish cooking foods already cooked on the surface but not internally more quickly. This system is recommended to finish cooking foods that are already well cooked on the surface, but not internally, which therefore require a moderate higher heat. Ideal for any type of food.</p>
 <p>Fan with upper and lower elements: The elements combined with the fan aim to provide more uniform heat, a similar method to conventional cooking, so pre-heat is required. Most suitable for items requiring slow cooking methods.</p>	 <p>Upper and lower element only: a traditional cooking method best suited for single items located in the centre of the oven. the top pf the oven will always be hottest. Ideal for roast, fruit cakes, bread etc.</p>
 <p>Circulaire: The combination of the fan and circular element around it gives a hot air cooking method. This provides many benefits including no preheat if cook time is more than 20 minutes, no flavour transfer when cooking different foods at the same time, less energy, and shorter cook times. Good for all types of food.</p>	 <p>ECO: The combination of the grill, fan and lower element is particularly suitable for cooking small quantities of food.</p>
 <p>Grill element: Using of grill gives excellent results when cooking meat of medium and small portions, especially when combined with a rotisserie (where possible). Also ideal for cooking sausages and bacon.</p>	 <p>Fan with grill element: The fan reduces the fierce heat from the grill, providing an excellent method of grilling various foods, chops, steaks, sausages etc. giving even browning and heat distribution, without drying out the food. The top two levels recommended for use, and the lower part of the oven can be used to keep items warm at the same time, an excellent facility when cooking a grilled breakfast. Half grill (centre portion only) is ideal for small quantities of food.</p>

-  Microwave: Penetrating straight into the food, microwaves cook very quickly and with considerable energy savings. Suitable for cooking without fat, they are also able to thaw and heat food without altering its original appearance and aroma. The microwave function can also be combined with conventional functions with all the resulting advantages. Ideal for all types of food.
-  Microwave + grill element: The use of the grill results in a perfect browning of the surface of the food. The action of microwaves allows instead of cooking in a short time the internal part of the food.
-  This function can reheat precooked dishes, without becoming dry or hard.
-  Compact appliances with a height of 45 cm - perfect solution to meet the functional requirements of kitchen sets of small height. Available in several types and in different styles.
-  Side lights: Two opposing side lights increase visibility inside the oven.
-  Air at 40°C provides the perfect environment for proving yeast type dough mixes. Simply select the function and place dough in the cavity for allotted
-  Sabbath: This function allows you to cook food whilst respecting the provisions of the Jewish day of rest.
-  Soft close: all models are equipped with advanced function of smooth closing of the door, which allows the device to close smoothly and quietly.
-  Tilting grill: the tilting grill can be easily unhooked to move the heating element and clean the roof of the appliance in one simple step.
-  The capacity indicates the amount of usable space in the oven cavity in litres.
-  Cooking with the simultaneous use of the heating element in combination with fan and microwave supply.
-  Fan combined with traditional cooking, where heat is generated from above and below, provides uniform heat. Adding the microwave function allows the same cooking results in less time.
-  Circulaire with upper and lower elements: The use of the fan with both elements allows food to be cooked quickly and effectively, ideal for large joints that require thorough cooking. It offers a similar result to rotisserie, moving the heat around the food, instead of moving the food itself, enabling any size or shape to be cooked.
-  Keep warm: This function allows you to keep precooked foods warm.
-  ECO-logic: option allows you to restrict the power limit of the appliance real energy saving.
-  Rapid preheat: The rapid preheat function can be used to reach the selected temperature in just a few minutes.
-  The oven cavity has 3 different cooking levels.
-  Electronic control: Allows you to maintain temperature inside the oven with the precision 2-3 ° C. This enables to cook meals that are very sensitive to temperature changes, such as cakes, souffles, puddings.
-  Vapor Clean: a simple cleaning function using steam to loosen deposits in the oven cavity.