

SF4400MCX1

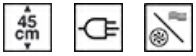

Category	45cm Compact Ovens
Product Family	Oven
Power supply	Electric
Heat source	Electric
Cooking method	Combi Microwave
EAN code	8017709315719



Aesthetics

Aesthetics	Cucina	Serigraphy colour	Black
Colour	Stainless steel	Serigraphy type	Symbols
Finishing	Fingerproof	Door	With panel
Design	Flat	Handle	Nuova Selezione
Material	Stainless steel	Handle Colour	Steel effect
Type of steel	Brushed	Logo	Embossed
Glass Type	Eclipse		

Controls

			
Display name	DigiScreen	Control setting	Touch bottoms
Display technology	LED		

Programs / Functions

No. of cooking functions	8
Automatic programmes	13
Traditional cooking functions	



Ciculaire



Large grill



Fan grill (large)



Ciculaire + bottom

Microwave functions



Microwave



Microwave + circulaire + fan



Microwave + grill

Microwave + Circulaire + bottom

Options



Time-setting options	Automatic end cooking
Minute minder	Yes
Timer	1

Controls Lock / Child Safety	Yes
Rapid pre-heating	Yes

Technical Features



Minimum Temperature	50 °C
Maximum temperature	200 °C
Shelf positions	3
No. of lights	1
Light type	Incandescent
Light power	20 W
Light when door is opened	Yes
Turntable	Yes
Turntable dimension	36 cm
Grill element - power	1750 W
Circular heating element - Power	1600 W

Heating suspended when door is opened	Yes
Door opening type	Standard opening
Door	Temperate door
Total no. of door glasses	3
Microwave stops when door is opened	Yes
Cooling system	Tangential
Usable cavity space dimensions (HxWxD)	210x420x390 mm
Temperature control	Electro-mechanical
Cavity material	Stainless steel
Microwave screen protection	Yes

Performance / Energy Label

Net volume of the cavity 44 litres

Microwave effective power 900 W







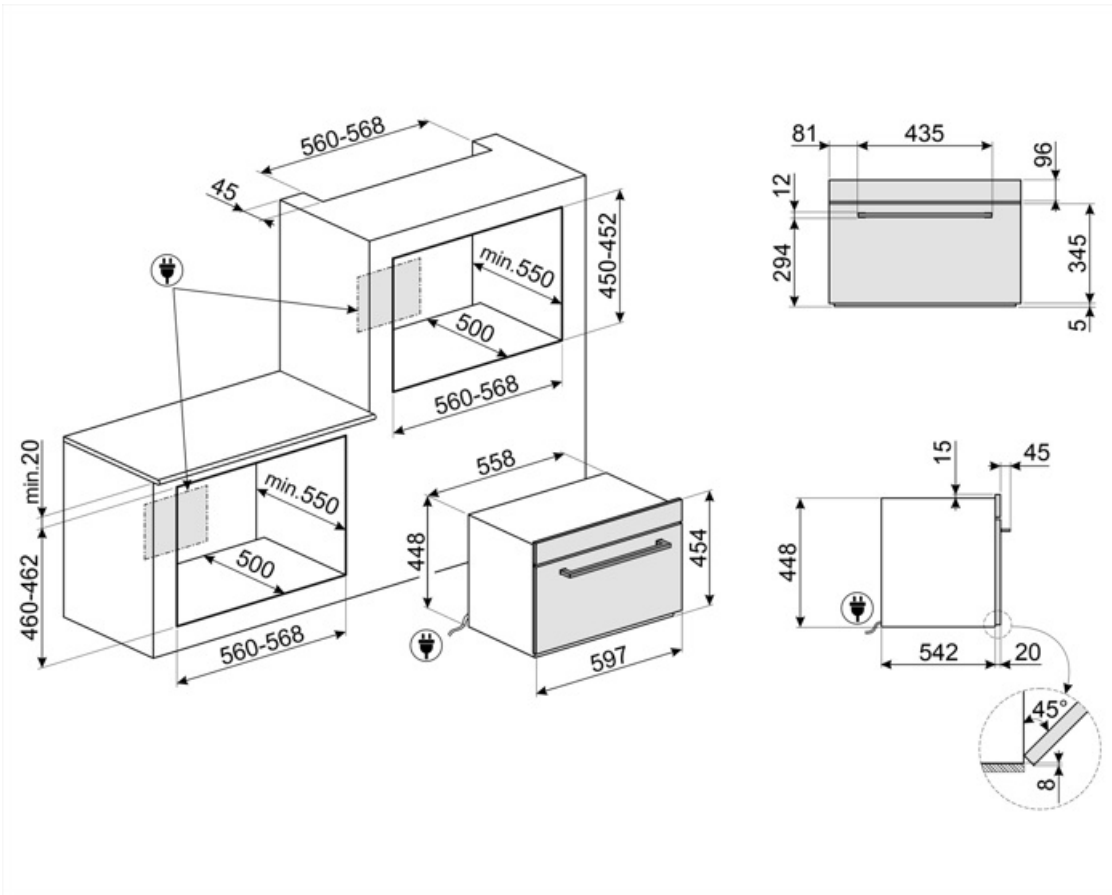











Electrical Connection

Voltage	230 V
Current	15 A
Nominal power (W)	3350 W

Frequency (Hz)	50 Hz
Power supply cable length	150 cm



Symbols glossary

 <p>Child lock: some models are fitted with a device to lock the programme/cycle so it cannot be accidentally changed.</p>	 <p>Combination microwave: This oven allows to combine two different ways of cooking (Traditional with microwaves). Combined ovens increase cooking opportunities, while providing maximum flexibility of household appliances.</p>
 <p>Air cooling system: to ensure a safe surface temperatures.</p>	 <p>Triple glazed doors: Number of glazed doors.</p>
 <p>Electric</p>	 <p>Enamel interior: The enamel interior of all Smeg ovens have a special antacid lining which helps keep the interior clean by reducing the amount of cooking grease adhering to it.</p>
 <p>Circulaire with lower element: The addition of the lower element adds extra heat at the base for food which requires extra cooking.</p>	 <p>Circulaire: The combination of the fan and circular element around it gives a hot air cooking method. This provides many benefits including no preheat if cook time is more than 20 minutes, no flavour transfer when cooking different foods at the same time, less energy, and shorter cook times. Good for all types of food.</p>
 <p>Grill element: Using of grill gives excellent results when cooking meat of medium and small portions, especially when combined with a rotisserie (where possible). Also ideal for cooking sausages and bacon.</p>	 <p>Fan with grill element: The fan reduces the fierce heat from the grill, providing an excellent method of grilling various foods, chops, steaks, sausages etc. giving even browning and heat distribution, without drying out the food. The top two levels recommended for use, and the lower part of the oven can be used to keep items warm at the same time, an excellent facility when cooking a grilled breakfast. Half grill (centre portion only) is ideal for small quantities of food.</p>
 <p>Microwave: Penetrating straight into the food, microwaves cook very quickly and with considerable energy savings. Suitable for cooking without fat, they are also able to thaw and heat food without altering its original appearance and aroma. The microwave function can also be combined with conventional functions with all the resulting advantages. Ideal for all types of food.</p>	 <p>Cooking with the simultaneous use of the heating element in combination with fan and microwave supply.</p>
 <p>Microwave + grill element: The use of the grill results in a perfect browning of the surface of the food. The action of microwaves allows instead of cooking in a short time the internal part of the food.</p>	 <p>Compact appliances with a height of 45 cm - perfect solution to meet the functional requirements of kitchen sets of small height. Available in several types and in different styles.</p>
 <p>Rapid preheat: The rapid preheat function can be used to reach the selected temperature in just a few minutes.</p>	 <p>The oven cavity has 3 different cooking levels.</p>
 <p>The capacity indicates the amount of usable space in the oven cavity in litres.</p>	 <p>The touch timer display or DigiScreen guarantees simple functionality. They display the time, set programmed cooking and the minute minder timer.</p>