

SF4400MCX1



Category	45 cm
Product Family	Oven
Power supply	Electric
Heat source	ELECTRICITY
Cooking method	Combi Microwave
Cleaning system	Ever Clean enamel
EAN code	8017709315719



Aesthetics

Aesthetic	Selezione	Serigraphy colour	Black
Colour	Stainless steel	Serigraphy type	Symbols
Finishing	Fingerproof	Door	With panel
Design	Flat	Handle	Nuova Selezione
Material	Stainless steel	Handle Colour	Steel effect
Type of steel	Brushed	Logo	Embossed
Glass Type	Eclipse		

Controls

Display name	DigiScreen	Control setting	Touch bottoms
Display technology	LED		

Programs / Functions main oven

No. of cooking functions	8
Automatic programmes	13
Traditional cooking functions	

Circulaire	Large grill	Fan grill (large)
Circulaire + bottom		

Microwave functions



Microwaves + Circulaire + bottom

Options

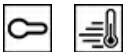

Time-setting options	Automatic end cooking	Controls Lock / Child Safety	Yes
Minute minder	Yes	Rapid pre-heating	Yes
Timer	1		

Technical Features



Capacity (Lt)	<50 l	Circular heating element - Power	1600 W
Minimum Temperature	50 °C	Heating suspended when door is opened	Yes
Maximum temperature	200 °C	Door opening type	Standard opening
No. of shelves	3	Door	Temperate door
No. of lights	1	Total no. of door glasses	3
Light type	Incandescent	Microwave stops when door is opened	Yes
Light Power	20 W	Cooling system	Tangential
Light when door is opened	Yes	Usable cavity space dimensions (HxWxD)	210x420x390 mm
Turntable	Yes	Temperature control	Electro-mechanical
Turntable dimension	36 cm	Cavity material	Stainless steel
Grill element - power	1750 W	Microwave screen protection	Yes

Performance / Energy Label

Net volume of the cavity	44 l	Microwave effective power	900 W
---------------------------------	------	----------------------------------	-------

Electrical Connection

Voltage	230 V	Nominal power	3350 W
Plug	Not present	Frequency (Hz)	50 Hz
Current	15 A	Power supply cable length	150 cm

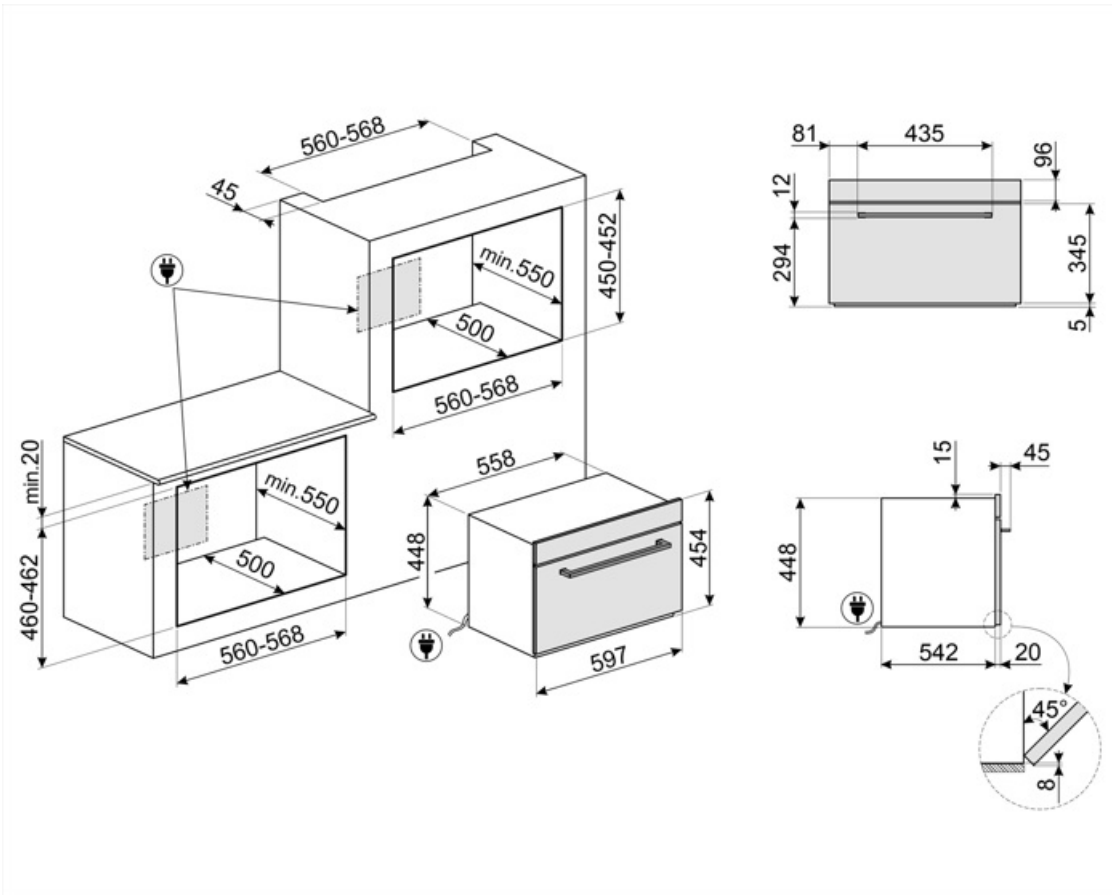



















Compatible Accessories

STONE2

Rectangular pizza stone without handles, suitable for 45cm and 60cm wide ovens. Dimensions W42 x H1.8 x D37.5cm. Ideal for cooking pizzas with the same results as a typical wood-fired oven. Can also be used for baking bread, focaccias and other recipes such as pies, flans or biscuits



Symbols glossary

 <p>Child lock: some models are fitted with a device to lock the programme/cycle so it cannot be accidentally changed.</p>	 <p>Combination microwave: This oven allows to combine two different ways of cooking (Traditional with microwaves). Combined ovens increase cooking opportunities, while providing maximum flexibility of household appliances.</p>
 <p>Air cooling system: to ensure a safe surface temperatures.</p>	 <p>4.3 inch display with LED technology, usability with knobs + 3 touch keys</p>
 <p>Triple glazed doors: Number of glazed doors.</p>	 <p>Electric</p>
 <p>Ever Clean Enamel: Ever Clean enamel is applied electrostatically, corner to corner and edge to edge to prevent cracking or cracks over time. It is a particular pyrolytic enamel, resistant to acids which, in addition to being pleasantly bright, promotes greater cleaning of the oven walls, thanks to its lower porosity. It is baked at over 850 °C and slowly polymerized at a scientifically determined rate to ensure uniform depth and strength. Ever Clean enamel creates an impeccable finish both on the inside of the oven and on the trays, making the surfaces of the oven incredibly easy to maintain over time as it reduces the adhesion of fat during cooking.</p>	 <p>Circulaire with lower element: The addition of the lower element adds extra heat at the base for food which requires extra cooking.</p>
 <p>Circulaire: it is the perfect function for cooking all types of dishes in a more delicate way. The heat comes from the back of the oven and is distributed quickly and evenly. The fan is active. It is also ideal for cooking on multiple levels without mixing smells and flavors.</p>	 <p>Grill: Very intense heat coming only from above from a double heating element. The fan is not active. Provides excellent grilling and gratinating results. Used at the end of cooking, it gives a uniform browning to dishes.</p>
 <p>Fan grill: very intense heat coming only from above from a double heating element. The fan is active. It allows the optimal grilling of thickest meats. Ideal for large cuts of meat.</p>	 <p>Microwave: Penetrating straight into the food, microwaves cook very quickly and with considerable energy savings. Suitable for cooking without fat, they are also able to thaw and heat food without altering its original appearance and aroma. The microwave function can also be combined with conventional functions with all the resulting advantages. Ideal for all types of food.</p>
 <p>Cooking with the simultaneous use of the heating element in combination with fan and microwave supply.</p>	 <p>Microwave + grill element: The use of the grill results in a perfect browning of the surface of the food. The action of microwaves allows instead of cooking in a short time the internal part of the food.</p>
 <p>Compact appliances with a height of 45 cm - perfect solution to meet the functional requirements of kitchen sets of small height. Available in several types and in different styles.</p>	 <p>Rapid preheating: cooking is preceded by the preheating phase which allows the cooking compartment to reach the set temperature. This option reduces the time by up to 50%.</p>
 <p>The oven cavity has 3 different cooking levels.</p>	 <p>The capacity indicates the amount of usable space in the oven cavity in litres.</p>