

SF4400MCX1



| | |
|-----------------|-------------------|
| Category | 45 cm |
| Product Family | Oven |
| Power supply | Electric |
| Heat source | ELECTRICITY |
| Cooking method | Combi Microwave |
| Cleaning system | Ever Clean enamel |
| EAN code | 8017709315719 |



Aesthetics

| | | | |
|---------------|-----------------|-------------------|-----------------|
| Aesthetic | Selezione | Serigraphy colour | Black |
| Colour | Stainless steel | Serigraphy type | Symbols |
| Finishing | Fingerproof | Door | With panel |
| Design | Flat | Handle | Nuova Selezione |
| Material | Stainless steel | Handle Colour | Steel effect |
| Type of steel | Brushed | Logo | Embossed |
| Glass Type | Eclipse | | |

Controls

| | | | |
|--|------------|-----------------|---------------|
|  | | | |
| Display name | DigiScreen | Control setting | Touch bottoms |
| Display technology | LED | | |

Programs / Functions main oven

| | |
|-------------------------------|----|
| No. of cooking functions | 8 |
| Automatic programmes | 13 |
| Traditional cooking functions | |



Circulaire



Large grill



Fan grill (large)



Circulaire + bottom

Microwave functions



Microwaves + Circulaire + bottom

Options

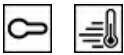

| | | | |
|-----------------------------|-----------------------|-------------------------------------|-----|
| Time-setting options | Automatic end cooking | Controls Lock / Child Safety | Yes |
| Minute minder | Yes | Rapid pre-heating | Yes |
| Timer | 1 | | |

Technical Features



| | | | |
|----------------------------------|--------|---|--------------------|
| Capacity (Lt) | 44 l | Circular heating element - Power | 1700 W |
| Minimum Temperature | 50 °C | Heating suspended when door is opened | Yes |
| Maximum temperature | 230 °C | Door opening type | Standard opening |
| No. of shelves | 2 | Door | Temperate door |
| No. of lights | 1 | Total no. of door glasses | 3 |
| Light type | LED | Microwave stops when door is opened | Yes |
| Light Power | 1,5 W | Cooling system | Tangential |
| Light when door is opened | Yes | Usable cavity space dimensions (HxWxD) | 250x420x420 mm |
| Turntable | Yes | Temperature control | Electro-mechanical |
| Turntable dimension | 36 cm | Cavity material | Stainless steel |
| Grill element - power | 1750 W | Microwave screen protection | Yes |

Performance / Energy Label







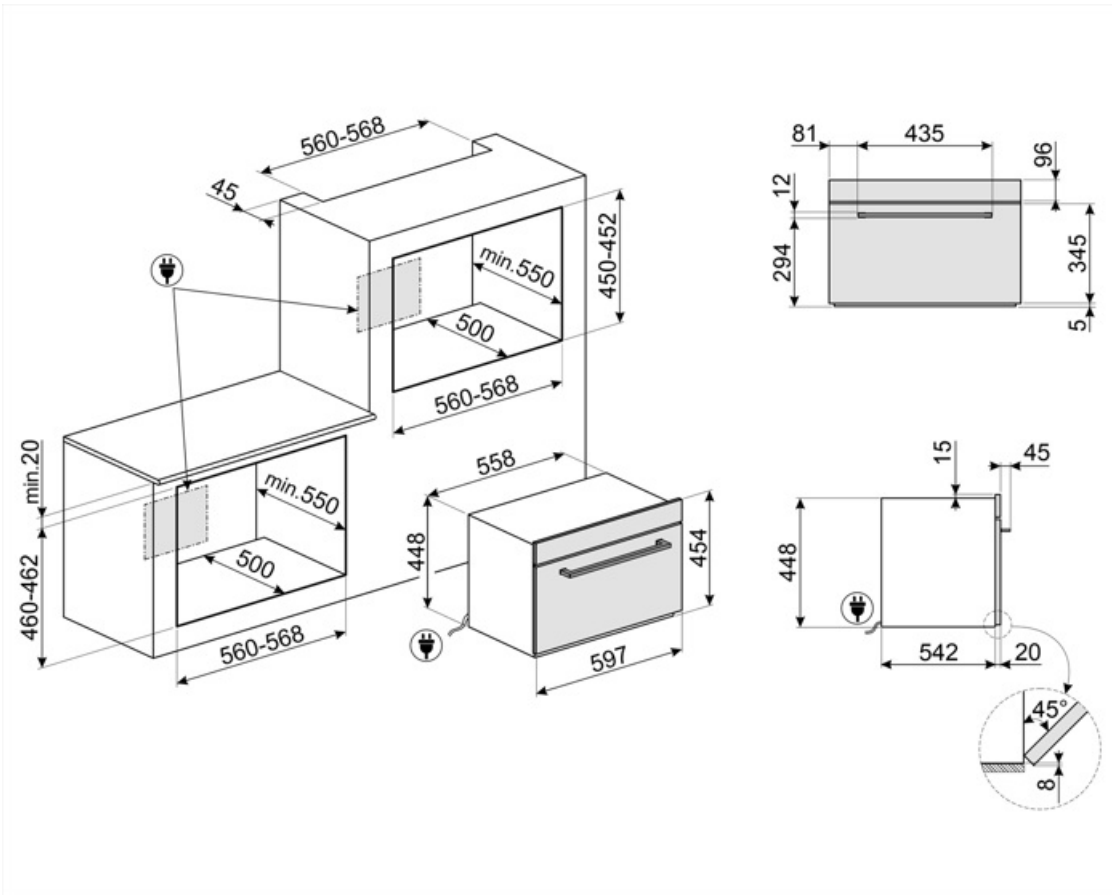











| | | | |
|---------------------------------|------|----------------------------------|-------|
| Net volume of the cavity | 44 l | Microwave effective power | 900 W |
|---------------------------------|------|----------------------------------|-------|

Electrical Connection

| | | | |
|----------------|-------------|----------------------------------|--------|
| Voltage | 230 V | Nominal power | 3350 W |
| Plug | Not present | Frequency (Hz) | 50 Hz |
| Current | 15 A | Power supply cable length | 150 cm |



Symbols glossary

| | |
|---|---|
|  <p>Child lock: some models are fitted with a device to lock the programme/cycle so it cannot be accidentally changed.</p> |  <p>Combination microwave: This oven allows to combine two different ways of cooking (Traditional with microwaves). Combined ovens increase cooking opportunities, while providing maximum flexibility of household appliances.</p> |
|  <p>Air cooling system: to ensure a safe surface temperatures.</p> |  <p>4.3 inch display with LED technology, usability with knobs + 3 touch keys</p> |
|  <p>Triple glazed doors: Number of glazed doors.</p> |  <p>Electric</p> |
|  <p>Ever Clean Enamel: Ever Clean enamel is applied electrostatically, corner to corner and edge to edge to prevent cracking or cracks over time. It is a particular pyrolytic enamel, resistant to acids which, in addition to being pleasantly bright, promotes greater cleaning of the oven walls, thanks to its lower porosity. It is baked at over 850 °C and slowly polymerized at a scientifically determined rate to ensure uniform depth and strength. Ever Clean enamel creates an impeccable finish both on the inside of the oven and on the trays, making the surfaces of the oven incredibly easy to maintain over time as it reduces the adhesion of fat during cooking.</p> |  <p>Circulaire with lower element: The addition of the lower element adds extra heat at the base for food which requires extra cooking.</p> |
|  <p>Circulaire: it is the perfect function for cooking all types of dishes in a more delicate way. The heat comes from the back of the oven and is distributed quickly and evenly. The fan is active. It is also ideal for cooking on multiple levels without mixing smells and flavors.</p> |  <p>Grill: Very intense heat coming only from above from a double heating element. The fan is not active. Provides excellent grilling and gratinating results. Used at the end of cooking, it gives a uniform browning to dishes.</p> |
|  <p>Fan grill: very intense heat coming only from above from a double heating element. The fan is active. It allows the optimal grilling of thickest meats. Ideal for large cuts of meat.</p> |  <p>Cooking with the simultaneous use of the heating element in combination with fan and microwave supply.</p> |
|  <p>Microwave + grill element: The use of the grill results in a perfect browning of the surface of the food. The action of microwaves allows instead of cooking in a short time the internal part of the food.</p> |  <p>Microwave: Penetrating straight into the food, microwaves cook very quickly and with considerable energy savings. Suitable for cooking without fat, they are also able to thaw and heat food without altering its original appearance and aroma. The microwave function can also be combined with conventional functions with all the resulting advantages. Ideal for all types of food.</p> |
|  <p>Compact appliances with a height of 45 cm - perfect solution to meet the functional requirements of kitchen sets of small height. Available in several types and in different styles.</p> |  <p>Rapid preheating: cooking is preceded by the preheating phase which allows the cooking compartment to reach the set temperature. This option reduces the time by up to 50%.</p> |
|  <p>The oven cavity has 2 different cooking levels.</p> |  <p>The capacity indicates the amount of usable space in the oven cavity in litres.</p> |