

SF4400MCX1



Categorie	45 cm
Product familie	Oven
Stroomvoorziening	Elektrisch
Warmtebron	Elektriciteit
Bereidingswijze	Combi-microgolf
EAN-code	8017709315719



Design

Design	Elementi	Kleur serigrafie	Zwart
Kleur	Inox	Type zeefdruk	Symbolen
Afwerking	Fingerproof	Deur	Met paneel
Design	Plat	Handvat	Nuova Selezione
Materiaal	Inox	Kleur handvat	Inox look
Type roestvrijstaal	Geborsteld inox	Logo	In reliëf
Type glas	Eclipse zwart glas		

Bediening

			
Display	DigiScreen	Bediening	Touch bottoms
Display	LED display		

Programma's / Functies

Aantal kookfuncties	8
Automatische programma's	13
Individualiseerbare recepten	No

Traditionele bereidingsfuncties



Circulatie (ventilator + circulaire)



Grote grill



Ventilator + grote grill



Circulaire + onderwarmte

Bereidingsfuncties met microgolven



Microgolfoven



Microgolf + circulaire + ventilator



Microgolf + grill

Microgolf + Circulaire +

Onderwarmte

Opties

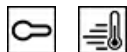

Tijdsinstelling
Timer
Timer

Einde kooktijd
Ja
1

Kinderbeveiliging
Snel voorverwarmen

Ja
Ja

Technische specificaties



Inhoud (l) 44 l
Minimum temperatuur 50 °C
Maximum temperatuur 230 °C
Aantal kookniveaus 2
Aantal lampen 1
Type lamp LED
Vermogen lamp 1.5 W
Verlichting bij opening deur Ja
Draaiplateau Ja
Afmeting draaiplateau 36 cm
Grill - vermogen 1750 W

Circulatie - vermogen 1700 W
Warmte onderbroken bij Ja
openen deur
Opening deur Standaard opening
Deur Temperatuur
gecontroleerde deur
Totaal aantal ruiten 3
Automatische
uitschakeling microgolf
bij openen deur Ja
Koelsysteem Mantelkoeling
Afmetingen bruikbare
interne ovenruimte
(hxbxd) 250x420x420 mm
Temperatuurcontrole Elektro-mechanisch
Materiaal ovenruimte Inox ovenruimte
Veiligheidsscherm Ja
microgolfdeur

Prestaties / energielabel

Netto volume 44 l

Effectief vermogen microgolf 900 W







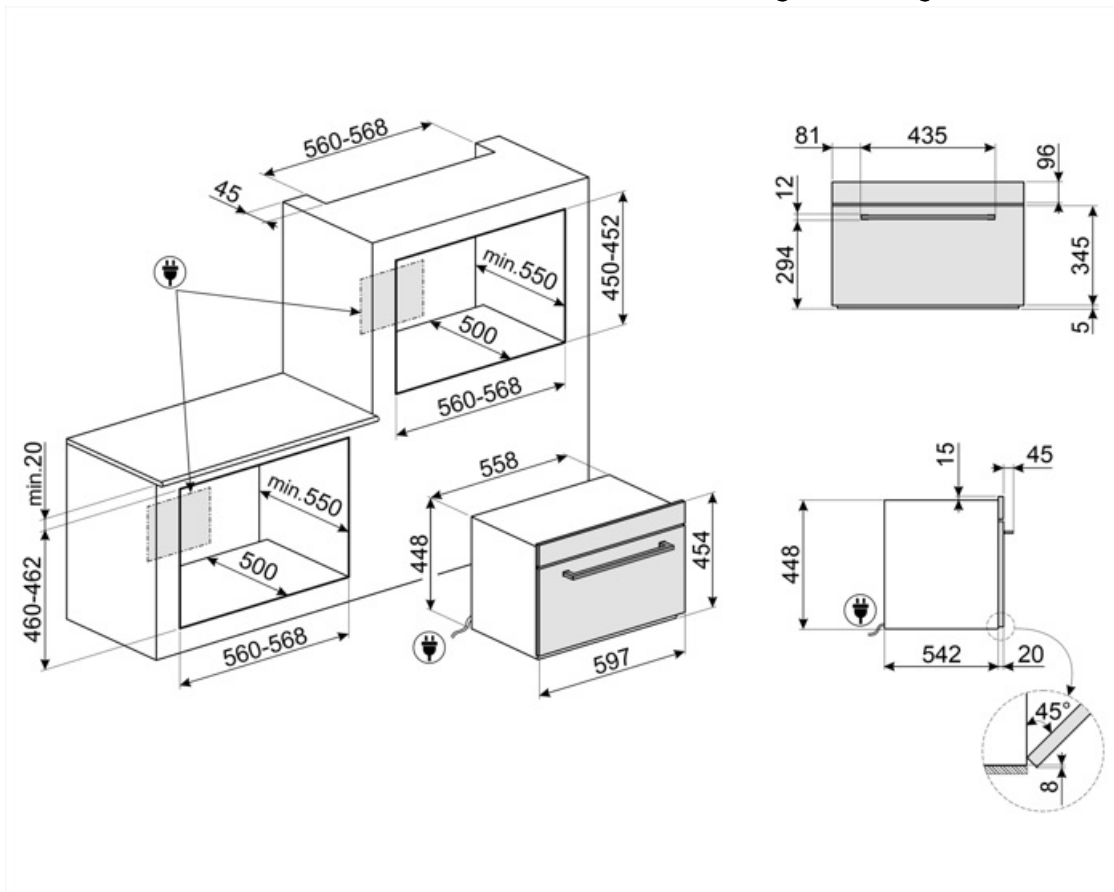







Elektrische aansluiting

Spanning 230 V
Stekker Nee
Stroom 15 A

Nominale aansluitwaarde 3350 W
Frequentie 50 Hz
Lengte voedingskabel 150 cm



Symbols glossary

 <p>Sommige modellen zijn voorzien van een functie om het programma/de cyclus te blokkeren zodat het niet per ongeluk kan aangepast worden.</p>	 <p>Combination microwave: This oven allows to combine two different ways of cooking (Traditional with microwaves). Combined ovens increase cooking opportunities, while providing maximum flexibility of household appliances.</p>
 <p>Air cooling system: to ensure a safe surface temperatures.</p>	 <p>Triple glazed doors: Number of glazed doors.</p>
 <p>Elektrische aansluiting</p>	 <p>Ever Clean Enamel: Ever Clean enamel is applied electrostatically, corner to corner and edge to edge to prevent cracking or cracks over time. It is a particular pyrolytic enamel, resistant to acids which, in addition to being pleasantly bright, promotes greater cleaning of the oven walls, thanks to its lower porosity. It is baked at over 850 °C and slowly polymerized at a scientifically determined rate to ensure uniform depth and strength. Ever Clean enamel creates an impeccable finish both on the inside of the oven and on the trays, making the surfaces of the oven incredibly easy to maintain over time as it reduces the adhesion of fat during cooking.</p>
 <p>Circulaire met onderste element: De toevoeging van het onderste element voegt extra warmte toe aan de basis voor voedsel dat extra moet worden gekookt.</p>	 <p>Circulaire: De combinatie van de ventilator en het ronde element eromheen zorgt voor een hete lucht kookmethode. Dit biedt vele voordelen, waaronder geen voorverwarmen als de kooktijd meer dan 20 minuten bedraagt, geen smaakoverdracht bij het gelijktijdig bereiden van verschillende soorten voedsel, minder energie en kortere kooktijden. Geschikt voor alle soorten voedsel.</p>
 <p>Grill: Very intense heat coming only from above from a double heating element. The fan is not active. Provides excellent grilling and gratinating results. Used at the end of cooking, it gives a uniform browning to dishes.</p>	 <p>Fan grill: very intense heat coming only from above from a double heating element. The fan is active. It allows the optimal grilling of thickest meats. Ideal for large cuts of meat.</p>
 <p>Microwave: Penetrating straight into the food, microwaves cook very quickly and with considerable energy savings. Suitable for cooking without fat, they are also able to thaw and heat food without altering its original appearance and aroma. The microwave function can also be combined with conventional functions with all the resulting advantages. Ideal for all types of food.</p>	 <p>Cooking with the simultaneous use of the heating element in combination with fan and microwave supply.</p>
 <p>Microwave + grill element: The use of the grill results in a perfect browning of the surface of the food. The action of microwaves allows instead of cooking in a short time the internal part of the food.</p>	 <p>Compacte toestellen met een hoogte van 45 cm - perfecte oplossing om te voldoen aan de functionele eisen van keukensets met een kleine hoogte. Verkrijgbaar in verschillende soorten en in verschillende stijlen.</p>



Rapid preheating: cooking is preceded by the preheating phase which allows the cooking compartment to reach the set temperature. This option reduces the time by up to 50%.



The oven cavity has 2 different cooking levels.



The capacity indicates the amount of usable space in the oven cavity in litres.



DIGI screen display + bedieningsknoppen