

SF4400MCX1



Categorie	45 cm
Familie	Oven
Voeding	Elektrisch
Warmte bron	Elektrisch
Bereidingswijze	Combi-magnetron
EAN-code	8017709315719



Design





Esthetiek	Selezione	Kleur serigrafie	Zwart
Kleur	Roestvrij staal	Type zeefdruk	Symbolen
Afwerking	Vingervlekvrij	Deur	Met paneel
Design	Plat	Handgreep	Nuova Selezione
Materiaal	Roestvrij staal	Kleur handgreep	Rvs look
Type roestvrijstaal	Geborsteld	Logo	In reliëf
Type glas	Zwart		

Bediening

			
Naam display	DigiScreen	Regeling bediening	Touch bottoms
Display technologie	Led		

Programma's / functies

Aantal kookfuncties	8
Automatische programma's	13
Personaliseerbare recepten	No
Traditionele kookfuncties	

 Circulaire	 Grote vlak-grill	 Fan grill (large)
 Circulaire + bottom		

Bereidingsfuncties met microgolven



Magnetron



Circulaire



Magnetron met grill

Oven met magnetronfunctie

Opties



Opties tijdsprogrammering

Einde kooktijd

Kinderbeveiliging

Ja

Timer

Ja

Snelle voorverwarming

Ja

Timer

1

Technische specificaties



Inhoud (l)

<50 l

Minimum temperatuur

50 °C

Maximum temperatuur

200 °C

Aantal kookniveaus

3

Aantal lampen

1

Soort verlichting

Gloeilamp

Vermogen lamp

20 W

Automatische inschakeling verlichting bij openen deur

Ja

Draaiplateau

Ja

Diameter draaiplateau

36 cm

Grill - vermogen

1750 W

Circulatie - vermogen

1600 W

Automatische uitschakeling

Ja

verhittingselementen bij openen deur

Deur openen

Standaard opening

Deur

Temperatuur gecontroleerde deur

Totaal aantal ruiten

3

Automatische uitschakeling magnetron bij openen deur

Ja

Koelsysteem

Mantelkoeling

Afmetingen bruikbare interne ovenruimte (hxbxd)

210x420x390 mm

Temperatuurregeling

Elektro-mechanisch

Materiaal ovenruimte

Roestvrij staal

Veiligheidsscherm magnetrondeur

Ja

Prestaties / energielabel

Netto inhoud

44 l

Effectief magnetronvermogen

900 W

Elektrische aansluiting

Spanning

230 V

Stekker

Nee

Nominale aansluitwaarde

3350 W

Frequentie

50 Hz

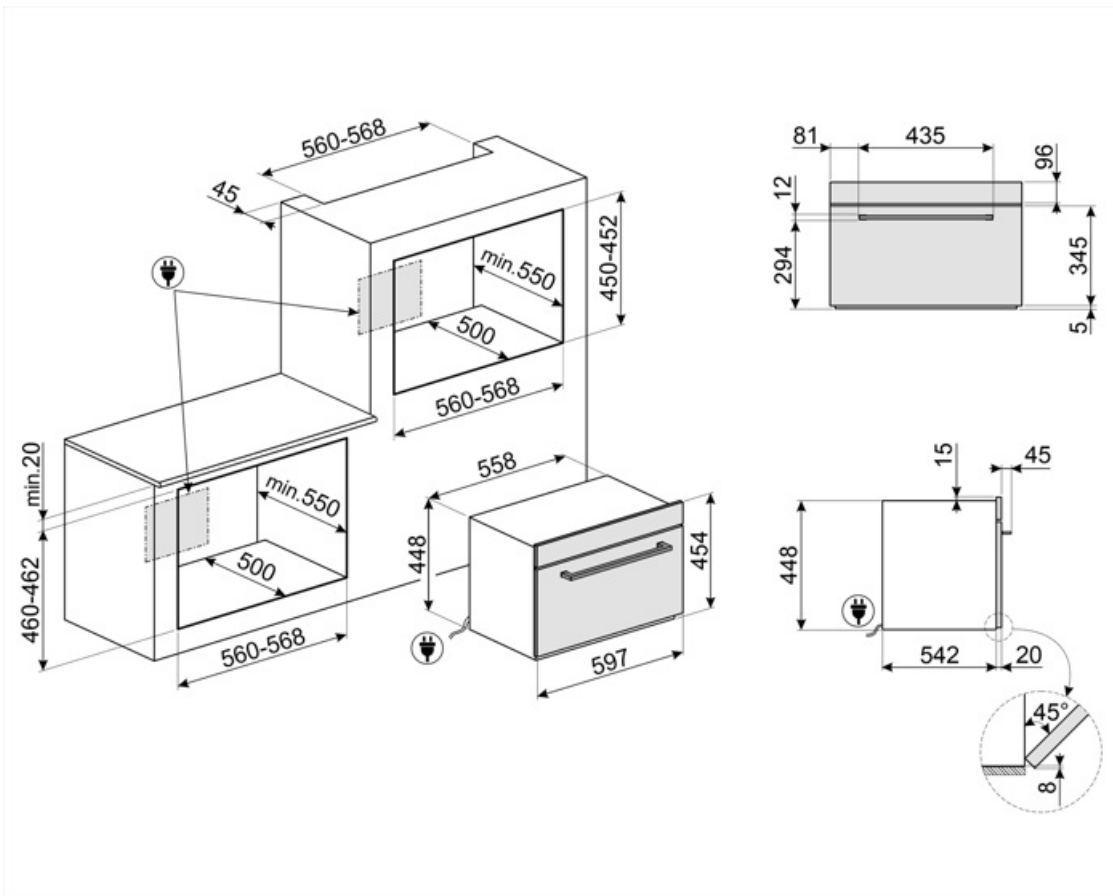

















Compatibile Accessoirs

STONE2

Rectangular pizza stone without handles, suitable for 45cm and 60cm wide ovens. Dimensions W42 x H1.8 x D37.5cm. Ideal for cooking pizzas with the same results as a typical wood-fired oven. Can also be used for baking bread, focaccias and other recipes such as pies, flans or biscuits



Symbols glossary

 <p>Kinderslot: sommige modellen zijn voorzien van een apparaat om het programma / de cyclus te vergrendelen zodat het niet kan per ongeluk veranderd</p>	 <p>Combination microwave: This oven allows to combine two different ways of cooking (Traditional with microwaves). Combined ovens increase cooking opportunities, while providing maximum flexibility of household appliances.</p>
 <p>Luchtkoelsysteem: om een veilig oppervlak te garanderen temperaturen.</p>	 <p>Deuren met driedubbele beglazing: aantal glazen deuren.</p>
 <p>Electric</p>	 <p>Geëmailleerde binnenkant: De geëmailleerde binnenkant van alle Smeg-ovens heeft een speciale antacidumvoering die helpt om de binnenkant schoon te houden door de hoeveelheid kookvet te verminderen.</p>
 <p>Circulaire with lower element: The addition of the lower element adds extra heat at the base for food which requires extra cooking.</p>	 <p>Circulaire: it is the perfect function for cooking all types of dishes in a more delicate way. The heat comes from the back of the oven and is distributed quickly and evenly. The fan is active. It is also ideal for cooking on multiple levels without mixing smells and flavors.</p>
 <p>De warmte wordt geproduceerd door het grill- en bovenelement. Verhitting over het volledige oppervlak. De thermostaat wordt, afhankelijk van het gerecht, in de regel op de maximale stand gezet. Bij een korte baktijd kan de ovendeur gesloten blijven; bij langere baktijd blijft deze gedeeltelijk geopend. Voor vleesgerechten (klein- en middelgroot), vleespennen, vis, groenten, gratineren etc.</p>	 <p>Ventilator met grillelement: De ventilator vermindert de felle hitte van de grill en biedt een uitstekende methode om verschillende soorten voedsel, karbonades, steaks, worstjes enz. Te grillen, waardoor het gelijkmatig bruin wordt en de warmte wordt verdeeld, zonder het voedsel uit te drogen. De bovenste twee niveaus die voor gebruik worden aanbevolen, en het onderste deel van de oven kunnen worden gebruikt om gerechten tegelijkertijd warm te houden, een uitstekende mogelijkheid bij het bereiden van een gegrild ontbijt. Halve grill (alleen middengedeelte) is ideaal voor kleine hoeveelheden voedsel.</p>
 <p>Microwave: Penetrating straight into the food, microwaves cook very quickly and with considerable energy savings. Suitable for cooking without fat, they are also able to thaw and heat food without altering its original appearance and aroma. The microwave function can also be combined with conventional functions with all the resulting advantages. Ideal for all types of food.</p>	 <p>Cooking with the simultaneous use of the heating element in combination with fan and microwave supply.</p>
 <p>Microwave + grill element: The use of the grill results in a perfect browning of the surface of the food. The action of microwaves allows instead of cooking in a short time the internal part of the food.</p>	 <p>Compact appliances with a height of 45 cm - perfect solution to meet the functional requirements of kitchen sets of small height. Available in several types and in different styles.</p>
 <p>Rapid preheating: cooking is preceded by the preheating phase which allows the cooking compartment to reach the set temperature. This option reduces the time by up to 50%.</p>	 <p>The oven cavity has 3 different cooking levels.</p>



The capacity indicates the amount of usable space in the oven cavity in litres.



4.3 inch display with LED technology, usability with knobs + 3 touch keys