

SF4400MX

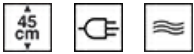

Category	45cm compact
Product Family	Oven
Power supply	Electric
Heat source	Electric
Cooking method	Microwave with grill
EAN code	8017709261207



Aesthetics

Aesthetics	Cucina	Serigraphy type	Symbols
Colour	Stainless steel	Door	With panel
Finishing	Fingerproof	Handle	Nuova Selezione
Design	Flat	Handle Colour	Steel effect
Material	Stainless steel	Logo	Embossed
Type of steel	Brushed	Control knobs	Cucina restyling
Glass Type	Eclipse	Controls colour	Steel effect
Serigraphy colour	Black		

Controls

Display name	DigiScreen	Control setting	Control knobs
Display technology	LED	No. of controls	2

Programs / Functions

No. of cooking functions 3
 Traditional cooking functions



Microwave functions

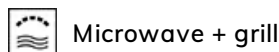

Options

Time-setting options	Automatic end cooking	Timer	1
Minute minder	Yes		

Technical Features



Shelf positions	2	Door opening type	Standard opening
No. of lights	1	Door	Temperate door
Light type	Incandescent	Total no. of door glasses	3
Light power	20 W	Microwave stops when door is opened	Yes
Light when door is opened	Yes	Cooling system	Tangential
Turntable	Yes	Usable cavity space dimensions (HxWxD)	210x420x390 mm
Turntable dimension	32 cm	Cavity material	Stainless steel
Grill element - power	1200 W	Microwave screen protection	Yes
Heating suspended when door is opened	Yes		

Performance / Energy Label



Net volume of the cavity	32 litres	Microwave effective power	1000 W
Number of cavities	1		

Accessories Included

Rack	2
-------------	---

Electrical Connection

Voltage	220-240 V	Frequency (Hz)	50 Hz
Current	14,3 A	Power supply cable length	150 cm
Nominal power (W)	3300 W		

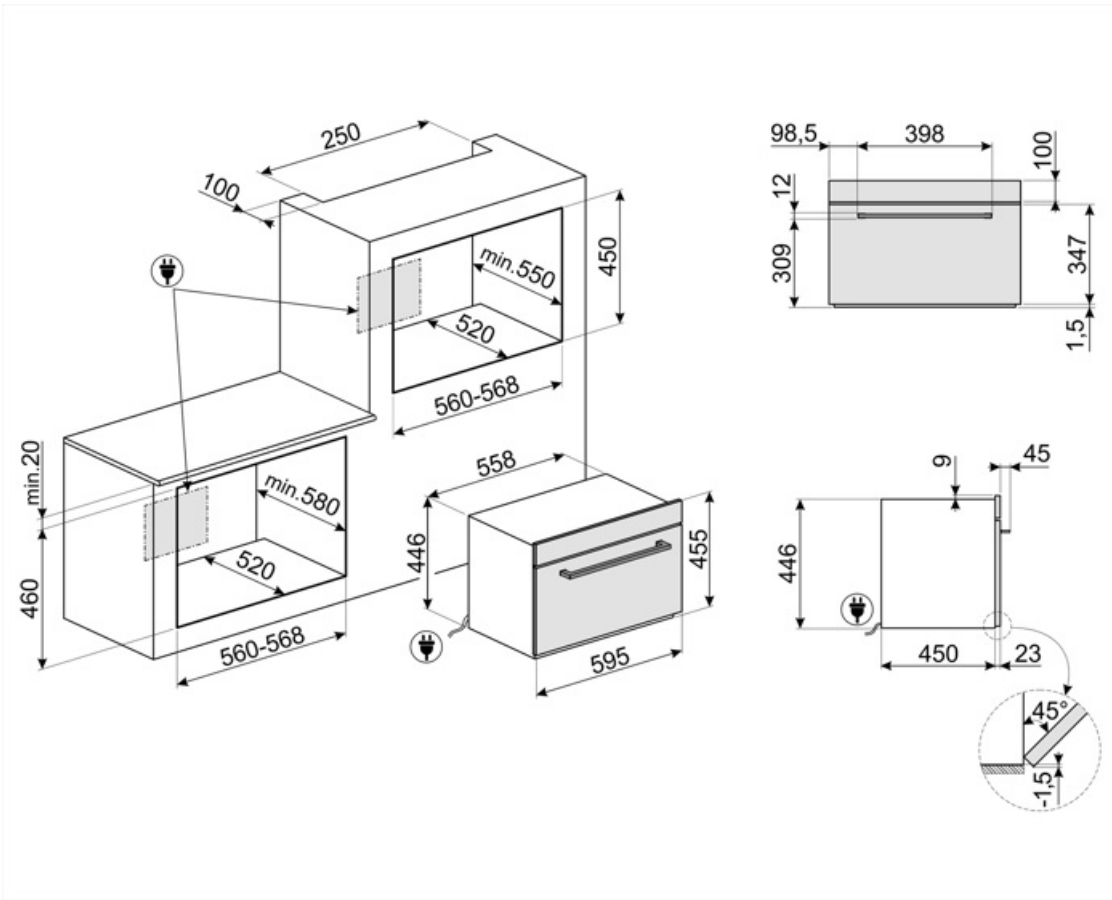

Not included accessories

GTP

Partially extractable telescopic guides (1 level) Extraction: 300 mm Material: Stainless steel AISI 430 polished













GTT

Totally extractable telescopic guides (1 level) Extraction: 433 mm Material: Stainless steel AISI 430 polished



Symbols glossary

	Microwave energy shortens cooking times dramatically and produces energy savings.		Air cooling system: to ensure a safe surface temperatures.
	The touch timer display or DigiScreen guarantees simple functionality. They display the time, set programmed cooking and the minute minder timer.		Triple glazed doors: Number of glazed doors.
	Electric		Grill element: Using of grill gives excellent results when cooking meat of medium and small portions, especially when combined with a rotisserie (where possible). Also ideal for cooking sausages and bacon.
	Microwave: Penetrating straight into the food, microwaves cook very quickly and with considerable energy savings. Suitable for cooking without fat, they are also able to thaw and heat food without altering its original appearance and aroma. The microwave function can also be combined with conventional functions with all the resulting advantages. Ideal for all types of food.		Microwave + grill element: The use of the grill results in a perfect browning of the surface of the food. The action of microwaves allows instead of cooking in a short time the internal part of the food.
	Compact appliances with a height of 45 cm - perfect solution to meet the functional requirements of kitchen sets of small height. Available in several types and in different styles.		The oven cavity has 2 different cooking levels.
	The capacity indicates the amount of usable space in the oven cavity in litres.		