

SF4604WVCPNR

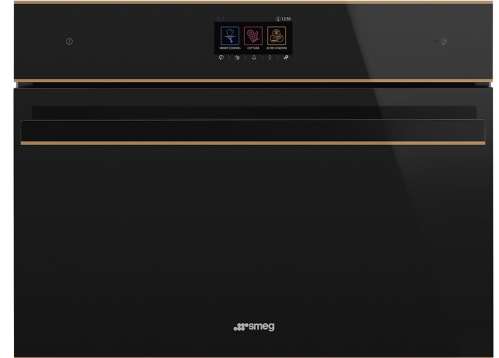

Category	45cm Compact Ovens
Product Family	Oven
Vitality system	Yes
Power supply	Electric
Heat source	Electric
Cooking method	Combi Steam
Cleaning system	Vapor Clean
EAN code	8017709275990



Aesthetics

Aesthetics	Dolce Stil Novo	Glass Type	Eclipse
Colour	Black	Door	Full glass
Finishing	Gloss	Handle	Dolce Stil Novo
Design	Flat	Handle Colour	Black
Component finish	Copper	Logo	Applied
Material	Glass		

Controls



Display name	VivoScreen	No. of display languages	11
Display technology	TFT	Display languages	Italiano, English (UK), Français (FR), Nederlands, Español (ES), Português (PT), Svenska, Русский, Deutsch (DE), Dansk, Polski
Control setting	Touch control		

Programs / Functions

No. of cooking functions	16
Automatic programmes	65
Customisable recipes	64

Traditional cooking functions

- Static
- Fan assisted
- Circulaire
- Turbo (circulaire + bottom + upper + fan)
- ECO
- Large grill
- Fan grill (large)
- Base
- Circulaire + bottom
- Pizza

Cooking functions with steam

- Manual steam
- Steam + bottom + upper + fan
- Steam + circulaire + fan
- Circulaire + Bottom + Fan
- Warming and re-generation
- Sous Vide

Other Steam functions

- Tank cleaning
- Water outlet
- Water input
- Descaling programme

Other functions

- Defrost by time
- Defrost by weight
- Proving
- Keep warm
- Plate rack/warmer
- Sabbath

Cleaning functions

- Vapor Clean

Options



- | | | | |
|-------------------------------------|---------------------------------------|-----------------------------|-------------------------------------|
| Time-setting options | Delay start and automatic end cooking | Showroom demo option | Yes |
| Minute minder | Yes | Demo-tutorial mode | Yes |
| Timer | 3 | Touch guide | Yes |
| Controls Lock / Child Safety | Yes | History | Yes, the last 10 functions utilised |
| | | Rapid pre-heating | Yes |
| | | Instant GO | Yes |

Other options	Keep warm, Eco light, Language setting, Digital clock display, Brightness, Eco-logic, Tones, Tones volume
Cooking with probe thermometer	Yes
Smart cooking	Yes

Technical Features



Capacity (Lt)	41 l	Door	Temperate door
Minimum Temperature	30 °C	Removable door	Yes
Maximum temperature	250 °C	Full glass inner door	Yes
Shelf positions	3	Removable inner door	Yes
No. of lights	1	Total no. of door glasses	3
Light type	Halogen	Soft Close hinges	Yes
User-replaceable light	Yes	Cooling system	Tangential
Light power	40 W	Cooling duct	Single
Light when door is opened	Yes	Usable cavity space dimensions (HxWxD)	212x462x407 mm
Lower heating element power	1000 W	Temperature control	Electronic
Grill element - power	2000 W	Cavity material	Easy clean enamel
Circular heating element - Power	1400 W	Water loading	Fill&Hide, automatic
Heating suspended when door is opened	Yes	Tank capacity	1,2 l
Boiler - Power	900 W	Steam stops when door is opened	Yes
Door opening type	Standard opening		

Performance / Energy Label



Energy efficiency class	A+	Energy consumption in forced air convection	2.12 MJ
Net volume of the cavity	41 litres	Energy consumption per cycle in fan-forced convection	0.59 kWh
Energy consumption per cycle in conventional mode	0.85 kWh	Number of cavities	1
Energy consumption in conventional mode	3.06 MJ	Energy efficiency index	81.9 %

Accessories Included



Chrome shelf	1	St/steel perforated deep tray (40mm)	1
Extra deep enamelled tray (40mm)	1		
Grill mesh	1		

St/steel tray (20mm) 1

Telescopic Guide rails, total Extraction 1

Temperature probe Yes, single point

Other Sponge/ Boiler cover/ Beaker

Electrical Connection

Voltage 220-240 V

Plug No

Current 14 A

Nominal power (W) 3100 W

Frequency (Hz) 50/60 Hz

Power supply cable length 115 cm

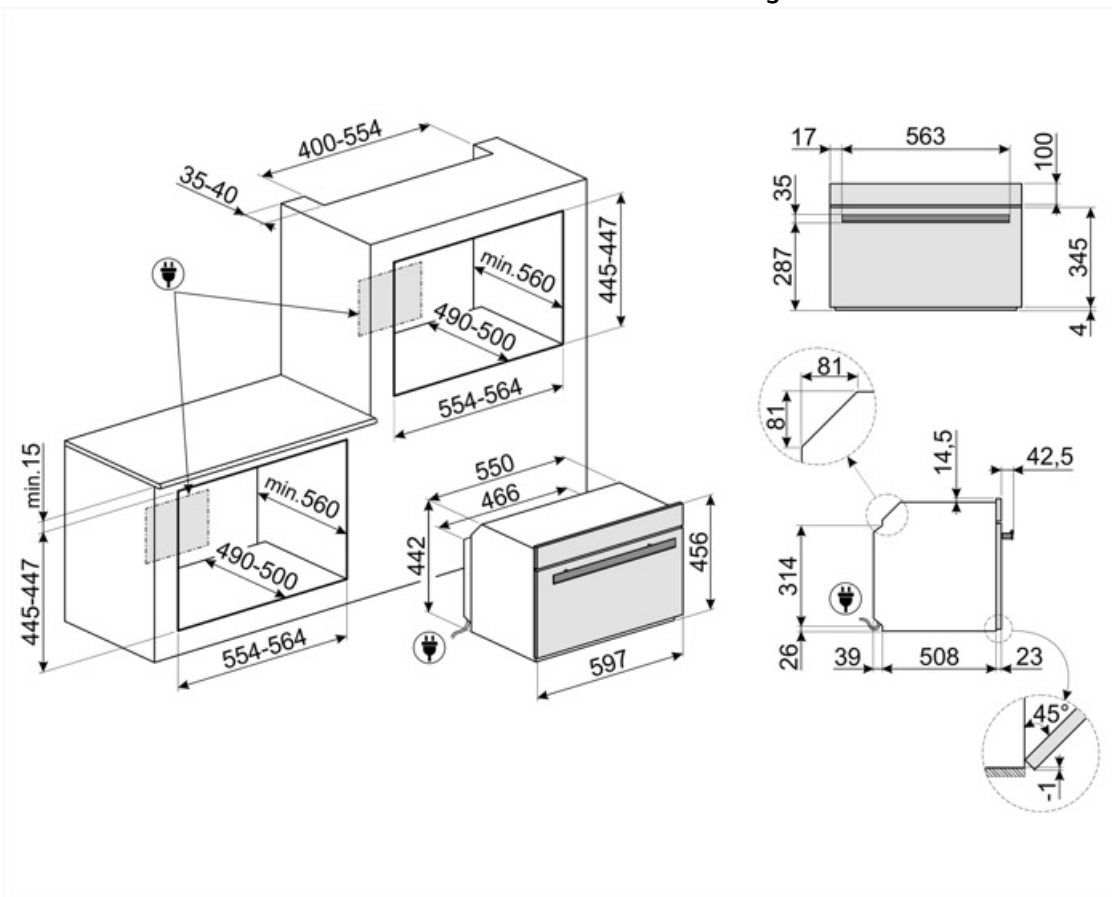

Compatible Accessories

BN620-1

Enamelled tray, 20mm deep



BX640

Stainless steel tray for steam oven,
H40xW455xD176 mm



PR3845N

Black spacer cover for furniture when
more ovens are installed in column.
Suitable for 45cm Dolce Stil Novo
compact ovens.



STONE2

Rectangular pizza stone without
handles, suitable for 45cm and 60cm
wide ovens. Dimensions W42 x H1.8 x
D37.5cm. Ideal for cooking pizzas with
the same results as a typical wood-fired
oven. Can also be used for baking bread,
focaccias and other recipes such as pies,
flans or biscuits



BN640

Enamelled tray, 40mm deep



PALPZ

Pizza shovel with fold away handle
width: 315mm length : 325mm





































PR3845X



















Antifingerprint stainless steel. Cover
for furniture in column installation of
more ovens



Symbols glossary

 <p>A+: Energy efficiency class A+ helps to save up to 10% energy compared to class A. Maximum performance with minimum consumption is guaranteed.</p>	 <p>Child lock: some models are fitted with a device to lock the programme/cycle so it cannot be accidentally changed.</p>
 <p>Combination steam: ovens can be used either as a steam oven, or as a traditional oven, or alternatively the two methods can be combined.</p>	 <p>Air cooling system: to ensure a safe surface temperatures.</p>
 <p>Defrost by time: with this function the time of thawing of foods are determined automatically.</p>	 <p>Defrost by weight: With this function the defrosting time is determined</p>
 <p>Descaling function: Is essential to remove excess deposits of limestone in the tank and allow the proper operation of the product. The need to perform this operation is signaled by the product itself.</p>	 <p>Triple glazed doors: Number of glazed doors.</p>
 <p>Automatic lighting switches off: for greater energy savings, the lighting switches off automatically after one minute from the start of cooking.</p>	 <p>ECO-logic: option allows you to restrict the power limit of the appliance real energy saving.</p>
 <p>Electric</p>	 <p>Enamel interior: The enamel interior of all Smeg ovens have a special antacid lining which helps keep the interior clean by reducing the amount of cooking grease adhering to it.</p>
 <p>A FULL STEAM oven has 3 steam COMBINATION cooking functions available, and it is also possible to use it to cook with PURE steam only. The steam is adjustable between 30% and 70% and there is the option of 100% pure steam if required. The water is loaded into the oven before cooking via an automatic loading tube. The oven calculates the exact amount of water required for the desired cooking function, up to 1.2lt. Water is introduced into the cavity, and becomes steam during cooking. Continuous steam is generated based on the setting at the start of cooking.</p>	 <p>Fan with upper and lower elements: The elements combined with the fan aim to provide more uniform heat, a similar method to conventional cooking, so pre-heat is required. Most suitable for items requiring slow cooking methods.</p>
 <p>Upper and lower element only: a traditional cooking method best suited for single items located in the centre of the oven. the top pf the oven will always be hottest. Ideal for roast, fruit cakes, bread etc.</p>	 <p>Lower heating element only: This function is ideal for foods that require extra base temperature without browning, e.g. pastry dishes, pizza. Also suitable for slow cooking of stews and casseroles.</p>
 <p>Circulaire with lower element: The addition of the lower element adds extra heat at the base for food which requires extra cooking.</p>	 <p>Circulaire: The combination of the fan and circular element around it gives a hot air cooking method. This provides many benefits including no preheat if cook time is more than 20 minutes, no flavour transfer when cooking different foods at the same time, less energy, and shorter cook times. Good for all types of food.</p>

-  **ECO:** The combination of the grill, fan and lower element is particularly suitable for cooking small quantities of food.
-  **Fan with grill element:** The fan reduces the fierce heat from the grill, providing an excellent method of grilling various foods, chops, steaks, sausages etc. giving even browning and heat distribution, without drying out the food. The top two levels recommended for use, and the lower part of the oven can be used to keep items warm at the same time, an excellent facility when cooking a grilled breakfast. Half grill (centre portion only) is ideal for small quantities of food.
-  **Sous Vide Cooking:** Steam function for perfect cooking of sous vide dishes. Enhances the taste of dishes and keeps their appearance and nutrients unaltered. Vacuum cooking (Sous Vide) made with the help of a steam oven is also an incredibly healthy and genuine type of cooking. The Sous Vide cooking technique allows heat to be efficiently transferred from the steam to the food, avoiding the loss of flavour due to oxidation and the evaporation of nutrients and moisture during cooking. Sous Vide cooking also allows better control over the cooking of food compared to traditional methods, ensuring uniform cooking results. It also allows cooking at a lower temperature than traditional cooking.
-  **Fan combined with traditional cooking,** where heat is generated from above and below, provides uniform heat. Adding the steam function allows the same cooking results in less time.
-  **FUN_STEAM_OTHER_WATER_IN_OUT_72dpi**
-  **Circulaire with upper and lower elements:** The use of the fan with both elements allows food to be cooked quickly and effectively, ideal for large joints that require thorough cooking. It offers a similar result to rotisserie cooking, moving the heat around the food, instead of moving the food itself, enabling any size or shape to be cooked.
-  **All glass inner door:** All glass inner door, a single flat surface which is simple to keep clean.
-  **Keep warm:** This function allows you to keep precooked foods warm.
-  **Grill element:** Using of grill gives excellent results when cooking meat of medium and small portions, especially when combined with a rotisserie (where possible). Also ideal for cooking sausages and bacon.
-  **Pizza function:** The simultaneous operation of three elements ensures an optimum cooking facility when used with the Smeg pizza stone.
-  **Steam cooking:** it`s a natural way of cooking for any kind of products, from vegetables to desserts, to preserve the nutritional and organoleptic properties of ingredients. Ideal for cooking without fat, to heat up food without drying. Steam is ideal for simultaneous cooking of meals that require different cooking times.
-  **Circulaire element with steam:** Cooking with the simultaneous use of the circular heating element in combination with fan and steam supply.
-  **Reheat:** This function can reheat precooked dishes, without becoming dry or hard.
-  **Compact appliances with a height of 45 cm -** perfect solution to meet the functional requirements of kitchen sets of small height. Available in several types and in different styles.
-  **The inner door glass:** can be removed with a few quick movements for cleaning.
-  **Side lights:** Two opposing side lights increase visibility inside the oven.

- | | |
|--|---|
|  <p>Warming up: An option for dish warming and keeping the prepared meals hot.</p> |  <p>Cooking with temperature probe: It is possible to display the temperature detected by the probe and set a target temperature that the dish must reach. When the core of the dish reaches the desired temperature, cooking stops</p> |
|  <p>Air at 40°C provides the perfect environment for proving yeast type dough mixes. Simply select the function and place dough in the cavity for allotted</p> |  <p>Rapid preheat: The rapid preheat function can be used to reach the selected temperature in just a few minutes.</p> |
|  <p>Sabbath: This function allows you to cook food whilst respecting the provisions of the Jewish day of rest.</p> |  <p>Touch guide: By holding down any symbol for 3 seconds you can get information on its function</p> |
|  <p>The oven cavity has 3 different cooking levels.</p> |  <p>Smart Cooking System: for the perfect cooking it is simply necessary choosing the kind and the weight of food and the cooking temperature: any other setting will be established automatically.</p> |
|  <p>Soft close: all models are equipped with advanced function of smooth closing of the door, which allows the device to close smoothly and quietly.</p> |  <p>To guarantee the optimal functioning of the appliance, it is suggested to carry out the tank cleaning roughly once every 2-3 months.</p> |
|  <p>Telescopic rails: allow you to pull out the dish and check it without having to remove it from the oven entirely.</p> |  <p>Electronic control: Allows you to maintain temperature inside the oven with the precision 2-3 ° C. This enables to cook meals that are very sensitive to temperature changes, such as cakes, souffles, puddings.</p> |
|  <p>Touch controls: Easy to use touch controls allow the appliance to be programmed at the touch of a button.</p> |  <p>Vapor Clean: a simple cleaning function using steam to loosen deposits in the oven cavity.</p> |
|  <p>The capacity indicates the amount of usable space in the oven cavity in litres.</p> |  <p>The capacity indicates the amount of usable space in the oven cavity in litres.</p> |
|  <p>The 4.3" VIVOscreen display offers an advanced colour touch interface, for automatic management of firing programmes such as Delta T, Multi-step and SameTime firing.</p> |  <p>Keep warm: the function allows to keep cooked food warm.</p> |
|  <p>Instant go: activating this option allows cooking to start immediately. Preheating is included in the cooking time and the oven will gradually reach the desired temperature. Particularly suitable for frozen foods.</p> | |