

SF478X



Category	60cm Single Ovens
Product Family	Oven
Power supply	Electric
Heat source	Electric
Cooking method	Thermo-ventilated
Cleaning system	Vapor Clean
EAN code	8017709174958



Aesthetics

Aesthetics	Cucina	Serigraphy colour	Black
Colour	Stainless steel	Door	With panel
Finishing	Fingerproof	Handle	Squared Selection
Design	Flat	Handle Colour	Silver
Material	Stainless steel	Logo	Embossed
Type of steel	Brushed	Control knobs	Cucina restyling
Glass Type	Clear1	Controls colour	Silver

Controls

Control setting	Control knobs / buttons	No. of controls	2
-----------------	-------------------------	-----------------	---

Programs / Functions

No. of cooking functions	8
--------------------------	---

Traditional cooking functions



Static



Fan assisted



Circulaire



Turbo (circulaire + bottom + upper + fan)



ECO



Large grill



Fan grill (large)



Base

Other functions



Defrost

Cleaning functions



Vapor Clean

Options

Time-setting options	Delay start and automatic end cooking	Minute minder	Yes
----------------------	---------------------------------------	---------------	-----

Technical Features



Capacity (Lt)	72 l	Heating suspended when door is opened	Yes
Minimum Temperature	50 °C	Door	Temperate door
Maximum temperature	250 °C	Removable door	Yes
Shelf positions	5	Full glass inner door	Yes
No. of lights	1	Removable inner door	Yes
Light type	Halogen	Total no. of door glasses	3
Light power	40 W	Cooling system	Tangential
Light when door is opened	Yes	Cooling duct	Single
Lower heating element power	1200 W	Speed Reduction Cooling System	Yes
Upper heating element - Power	1000 W	Usable cavity space dimensions (HxWxD)	360x460x425 mm
Grill element - power	1700 W	Temperature control	Electro-mechanical
Large grill - Power	2700 W	Cavity material	Easy clean enamel
Circular heating element - Power	2000 W		

Performance / Energy Label



Energy efficiency class	A
Net volume of the cavity	70 litres
Energy consumption per cycle in conventional mode	1,15 kWh
Energy consumption in conventional mode	4,14 MJ

Energy consumption in forced air convection	2,88 MJ
Energy consumption per cycle in fan-forced convection	0,80 kWh
Number of cavities	1
Energy efficiency index	95,2 %

Accessories Included

Chrome shelf	1	Grill mesh	1
Extra deep enamelled tray (40mm)	1		

Electrical Connection

Voltage	220-240 V	Nominal power (W)	3000 W
Plug	No	Frequency (Hz)	50/60 Hz
Current	13 A	Power supply cable length	115 cm

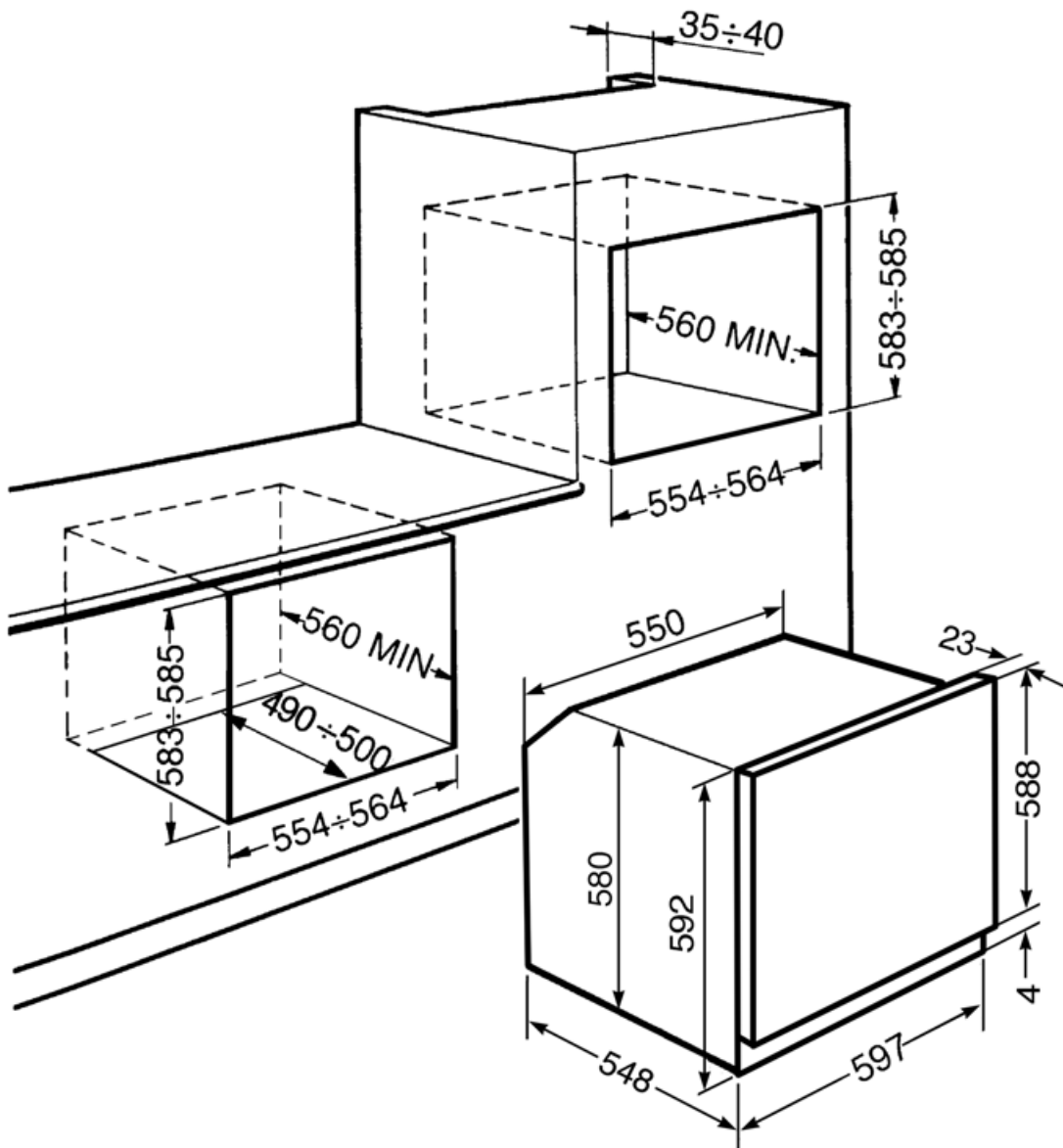

Compatible Accessories

BN620-1

Enamelled tray, 20mm deep



PALPZ

Pizza shovel with fold away handle
width: 315mm length : 325mm



STONE2

Rectangular pizza stone without handles, suitable for 45cm and 60cm wide ovens. Dimensions W42 x H1.8 x D37.5cm. Ideal for cooking pizzas with the same results as a typical wood-fired oven. Can also be used for baking bread, focaccias and other recipes such as pies, flans or biscuits



BN640

Enamelled tray, 40mm deep

























PR3845X

Antifingerprint stainless steel. Cover for furniture in column installation of more ovens



Symbols glossary

 <p>A: Product drying performance, measured from A+++ to D / G depending on the product family</p>	 <p>Air cooling system: to ensure a safe surface temperatures.</p>
 <p>With the switch on this symbol, no heating is possible even if the thermostat is turned.</p>	 <p>Triple glazed doors: Number of glazed doors.</p>
 <p>Electric</p>	 <p>Enamel interior: The enamel interior of all Smeg ovens have a special antacid lining which helps keep the interior clean by reducing the amount of cooking grease adhering to it.</p>
 <p>Fingerprint proof stainless steel: Fingerprint proof stainless steel keeps stainless steel looking as good as new.</p>	 <p>Fan with upper and lower elements: The elements combined with the fan aim to provide more uniform heat, a similar method to conventional cooking, so pre-heat is required. Most suitable for items requiring slow cooking methods.</p>
 <p>Upper and lower element only: a traditional cooking method best suited for single items located in the centre of the oven. the top pf the oven will always be hottest. Ideal for roast, fruit cakes, bread etc.</p>	 <p>Lower heating element only: This function is ideal for foods that require extra base temperature without browning, e.g. pastry dishes, pizza. Also suitable for slow cooking of stews and casseroles.</p>
 <p>Circulaire: The combination of the fan and circular element around it gives a hot air cooking method. This provides many benefits including no preheat if cook time is more than 20 minutes, no flavour transfer when cooking different foods at the same time, less energy, and shorter cook times. Good for all types of food.</p>	 <p>ECO: The combination of the grill, fan and lower element is particularly suitable for cooking small quantities of food.</p>
 <p>Grill element: Using of grill gives excellent results when cooking meat of medium and small portions, especially when combined with a rotisserie (where possible). Also ideal for cooking sausages and bacon.</p>	 <p>Fan with grill element: The fan reduces the fierce heat from the grill, providing an excellent method of grilling various foods, chops, steaks, sausages etc. giving even browning and heat distribution, without drying out the food. The top two levels recommended for use, and the lower part of the oven can be used to keep items warm at the same time, an excellent facility when cooking a grilled breakfast. Half grill (centre portion only) is ideal for small quantities of food.</p>
 <p>Circulaire with upper and lower elements: The use of the fan with both elements allows food to be cooked quickly and effectively, ideal for large joints that require thorough cooking. It offers a similar result to rotisserie, moving the heat around the food, instead of moving the food itself, enabling any size or shape to be cooked.</p>	 <p>All glass inner door: All glass inner door, a single flat surface which is simple to keep clean.</p>
 <p>The inner door glass: can be removed with a few quick movements for cleaning.</p>	 <p>Side lights: Two opposing side lights increase visibility inside the oven.</p>

-
-  The oven cavity has 5 different cooking levels.
 -  Tilting grill: the tilting grill can be easily unhooked to move the heating element and clean the roof of the appliance in one simple step.
 -  Vapor Clean: a simple cleaning function using steam to loosen deposits in the oven cavity.
 -  The capacity indicates the amount of usable space in the oven cavity in litres.
 -  The capacity indicates the amount of usable space in the oven cavity in litres.