

# SF4800MCPO



<b>Category</b>	45cm Compact Ovens
<b>Product Family</b>	Oven
<b>Power supply</b>	Electric
<b>Heat source</b>	Electric
<b>Cooking method</b>	Combi Microwave
<b>Cleaning system</b>	Vapor Clean
<b>EAN code</b>	8017709206420



## Aesthetics

<b>Aesthetics</b>	Coloniale	<b>Serigraphy type</b>	Symbols
<b>Colour</b>	Cream	<b>Door</b>	With panel
<b>Design</b>	Flat	<b>Handle</b>	Colonial
<b>Component finish</b>	Antique brass	<b>Handle Colour</b>	Antique brass
<b>Material</b>	Painted material	<b>Logo</b>	Silk screen
<b>Glass Type</b>	Clear1	<b>Control knobs</b>	Colonial
<b>Serigraphy colour</b>	Gold	<b>Controls colour</b>	Brassed

## Controls

<b>Control setting</b>	Control knobs	<b>No. of controls</b>	2
------------------------	---------------	------------------------	---

## Programs / Functions

<b>No. of cooking functions</b>	7
<b>Traditional cooking functions</b>	



Fan assisted







Criculaire



Large grill

## Microwave functions

-  Microwave
-  Microwave + bottom + top + fan
-  Microwave + circulaire + fan
-  Microwave + grill

## Other functions

-  Defrost by time
-  Defrost by weight

## Cleaning functions

-  Vapor Clean

## Options



<b>Time-setting options</b>	Delay start and automatic end cooking	<b>Other options</b>	Keep warm, Quick start
<b>Minute minder</b>	Yes	<b>Showroom demo option</b>	Yes
<b>Controls Lock / Child Safety</b>	Yes	<b>Rapid pre-heating</b>	Yes

## Technical Features



<b>Minimum Temperature</b>	30 °C	<b>Heating suspended when door is opened</b>	Yes
<b>Maximum temperature</b>	250 °C	<b>Door</b>	Temperate door
<b>Shelf positions</b>	3	<b>Total no. of door glasses</b>	3
<b>No. of lights</b>	2	<b>Microwave stops when door is opened</b>	Yes
<b>Light type</b>	Halogen	<b>Soft Close hinges</b>	Yes
<b>Light power</b>	40 W	<b>Cooling system</b>	Tangential
<b>Light when door is opened</b>	Yes	<b>Usable cavity space dimensions (HxWxD)</b>	212x462x407 mm
<b>Lower heating element power</b>	1000 W	<b>Temperature control</b>	Electronic
<b>Grill element - power</b>	2000 W	<b>Cavity material</b>	Easy clean enamel
<b>Circular heating element - Power</b>	1400 W	<b>Microwave screen protection</b>	Yes

## Performance / Energy Label



Net volume of the cavity 40 litres

Microwave effective power 1000 W

Number of cavities 1

## Accessories Included

Chrome shelf 1  
Grill mesh 1

Glass tray 1

## Electrical Connection

Voltage 220-240 V

Frequency (Hz) 50 Hz

Current 14 A

Power supply cable length 115 cm

Nominal power (W) 3100 W

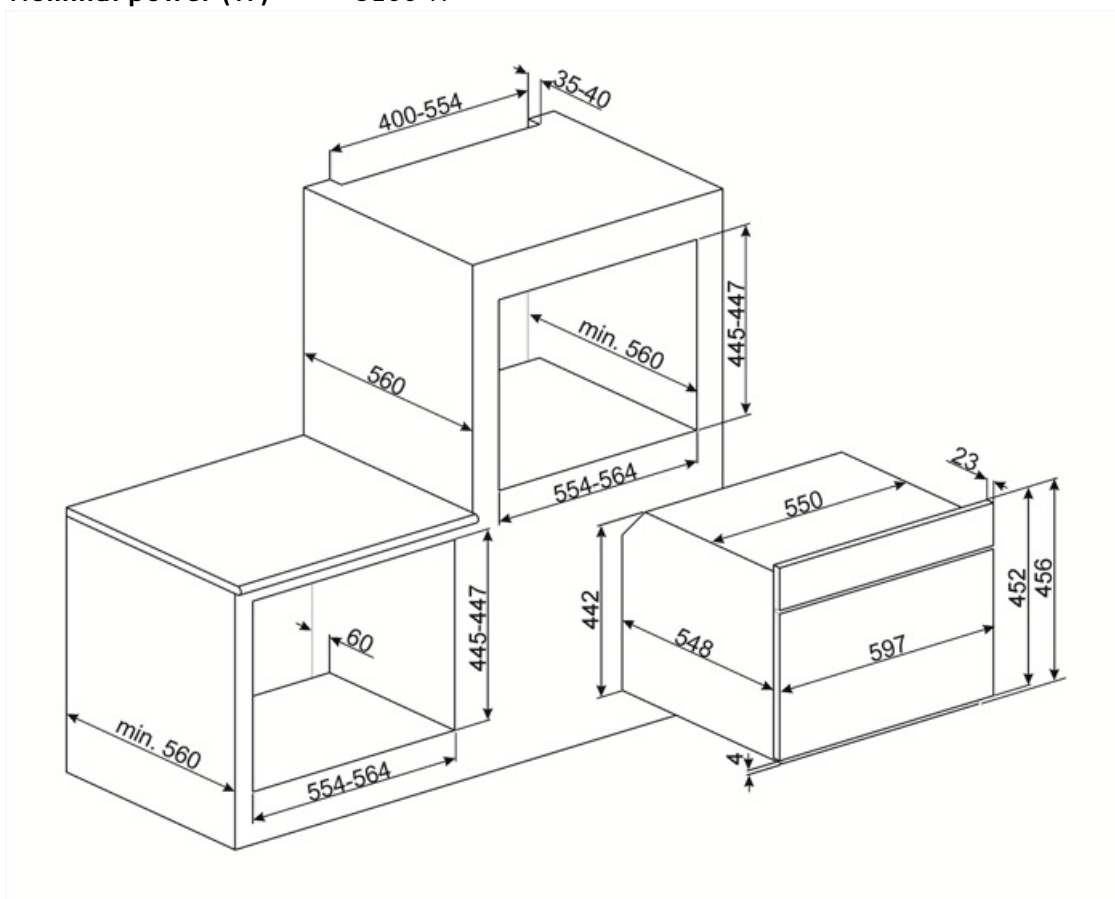

---

## Compatible Accessories

---

### **BN620-1**

Enamelled tray, 20mm deep



### **PALPZ**

Pizza shovel with fold away handle  
width: 315mm length : 325mm



### **BN640**

Enamelled tray, 40mm deep





























### **PR3845X**

Antifingerprint stainless steel. Cover  
for furniture in column installation of  
more ovens



## Symbols glossary

 <p>Child lock: some models are fitted with a device to lock the programme/cycle so it cannot be accidentally changed.</p>	 <p>Combination microwave: This oven allows to combine two different ways of cooking (Traditional with microwaves). Combined ovens increase cooking opportunities, while providing maximum flexibility of household appliances.</p>
 <p>Air cooling system: to ensure a safe surface temperatures.</p>	 <p>Defrost by time: with this function the time of thawing of foods are determined automatically.</p>
 <p>Defrost by weight: With this function the defrosting time is determined</p>	 <p>Triple glazed doors: Number of glazed doors.</p>
 <p>Electric</p>	 <p>Enamel interior: The enamel interior of all Smeg ovens have a special antacid lining which helps keep the interior clean by reducing the amount of cooking grease adhering to it.</p>
 <p>Fan with upper and lower elements: The elements combined with the fan aim to provide more uniform heat, a similar method to conventional cooking, so pre-heat is required. Most suitable for items requiring slow cooking methods.</p>	 <p>Circulaire: The combination of the fan and circular element around it gives a hot air cooking method. This provides many benefits including no preheat if cook time is more than 20 minutes, no flavour transfer when cooking different foods at the same time, less energy, and shorter cook times. Good for all types of food.</p>
 <p>Grill element: Using of grill gives excellent results when cooking meat of medium and small portions, especially when combined with a rotisserie (where possible). Also ideal for cooking sausages and bacon.</p>	 <p>Microwave: Penetrating straight into the food, microwaves cook very quickly and with considerable energy savings. Suitable for cooking without fat, they are also able to thaw and heat food without altering its original appearance and aroma. The microwave function can also be combined with conventional functions with all the resulting advantages. Ideal for all types of food.</p>
 <p>Cooking with the simultaneous use of the heating element in combination with fan and microwave supply.</p>	 <p>Microwave + grill element: The use of the grill results in a perfect browning of the surface of the food. The action of microwaves allows instead of cooking in a short time the internal part of the food.</p>
 <p>Fan combined with traditional cooking, where heat is generated from above and below, provides uniform heat. Adding the microwave function allows the same cooking results in less time.</p>	 <p>Compact appliances with a height of 45 cm - perfect solution to meet the functional requirements of kitchen sets of small height. Available in several types and in different styles.</p>
 <p>Keep warm: This function allows you to keep precooked foods warm.</p>	 <p>Side lights: Two opposing side lights increase visibility inside the oven.</p>
 <p>ECO-logic: option allows you to restrict the power limit of the appliance real energy saving.</p>	 <p>Rapid preheat: The rapid preheat function can be used to reach the selected temperature in just a few minutes.</p>

- 
-  The oven cavity has 3 different cooking levels.
-  Electronic control: Allows you to maintain temperature inside the oven with the precision 2-3 ° C. This enables to cook meals that are very sensitive to temperature changes, such as cakes, souffles, puddings.
-  Vapor Clean: a simple cleaning function using steam to loosen deposits in the oven cavity.
-  The capacity indicates the amount of usable space in the oven cavity in litres.
-  Soft close: all models are equipped with advanced function of smooth closing of the door, which allows the device to close smoothly and quietly.
-  Tilting grill: the tilting grill can be easily unhooked to move the heating element and clean the roof of the appliance in one simple step.
-  The capacity indicates the amount of usable space in the oven cavity in litres.