

# SF4800MCPO



<b>Categorie</b>	45 cm
<b>Familie</b>	Oven
<b>Voeding</b>	Elektrisch
<b>Warmte bron</b>	Elektrisch
<b>Bereidingswijze</b>	Combi-magnetron
<b>Reinigingssysteem</b>	Vapor Clean
<b>EAN-code</b>	8017709206420



## Design

<b>Esthetiek</b>	Coloniale	<b>Type zeefdruk</b>	Symbolen
<b>Kleur</b>	Crème	<b>Deur</b>	Met paneel
<b>Design</b>	Plat	<b>Handgreep</b>	Coloniale
<b>Afwerking componenten</b>	Antiek messing	<b>Kleur handgreep</b>	Antiek messing
<b>Materiaal</b>	Gelakt materiaal	<b>Logo</b>	Geëts
<b>Type glas</b>	Clear1	<b>Bedieningsknoppen</b>	Coloniale
<b>Kleur serigrafie</b>	Goud	<b>Kleur knoppen</b>	Messing

## Bediening

<b>Regeling bediening</b>	Bedieningsknoppen	<b>Aantal bedieningsknoppen</b>	2
---------------------------	-------------------	---------------------------------	---

## Programma's / functies

<b>Aantal kookfuncties</b>	7
<b>Automatische programma's</b>	No
<b>Personaliseerbare recepten</b>	No
<b>Traditionele kookfuncties</b>	

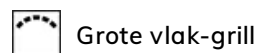

## Bereidingsfuncties met microgolven

 Magnetron  Geventileerd  Circulaire

 Microwave + grill

## Overige functies

 Ontdooien op tijd  Ontdooien op gewicht

## Schoonmaak functie

 Vapor Clean

## Opties



<b>Opties</b>	Automatische in- en uitschakeling	<b>Overige opties</b>	Warmhoudfunctie, Quick Start
<b>tijdprogrammering</b>		<b>Showroom demo optie</b>	Ja
<b>Timer</b>	Ja	<b>Snelle voorverwarming</b>	Ja
<b>Kinderbeveiliging</b>	Ja		

## Technische specificaties



<b>Minimum temperatuur</b>	30 °C	<b>Automatische uitschakeling</b>	Ja
<b>Maximum temperatuur</b>	250 °C	<b>verhittingselementen bij openen deur</b>	
<b>Aantal kookniveaus</b>	3	<b>Deur</b>	Temperatuur gecontroleerde deur
<b>Aantal lampen</b>	2	<b>Totaal aantal ruiten</b>	3
<b>Soort verlichting</b>	Halogeen	<b>Automatische uitschakeling magnetron bij openen deur</b>	Ja
<b>Vermogen lamp</b>	40 W	<b>Soft Close systeem</b>	Ja
<b>Automatische inschakeling verlichting bij openen deur</b>	Ja	<b>Koelsysteem</b>	Mantelkoeling
<b>Onderwarmte - vermogen</b>	1000 W	<b>Afmetingen bruikbare interne ovenruimte (hxbxd)</b>	212x462x407 mm
<b>Grill - vermogen</b>	2000 W	<b>Temperatuurregeling</b>	Elektronisch
<b>Circulatie - vermogen</b>	1400 W	<b>Materiaal ovenruimte</b>	Ever Clean emaille
		<b>Veiligheidsscherm magnetrondeur</b>	Ja

## Prestaties / energielabel



<b>Netto inhoud</b>	40 l	<b>Effectief magnetronvermogen</b>	1000 W
---------------------	------	------------------------------------	--------

Aantal ovens 1

## Meegeleverde accessoires

Ovenrooster met stop	1	Glazen ovenplaat	1
Inzetrooster	1		

## Elektrische aansluiting

Spanning	220-240 V	Frequentie	50 Hz
Stroom	14 A	Lengte voedingskabel	115 cm
Nominale aansluitwaarde	3100 W		

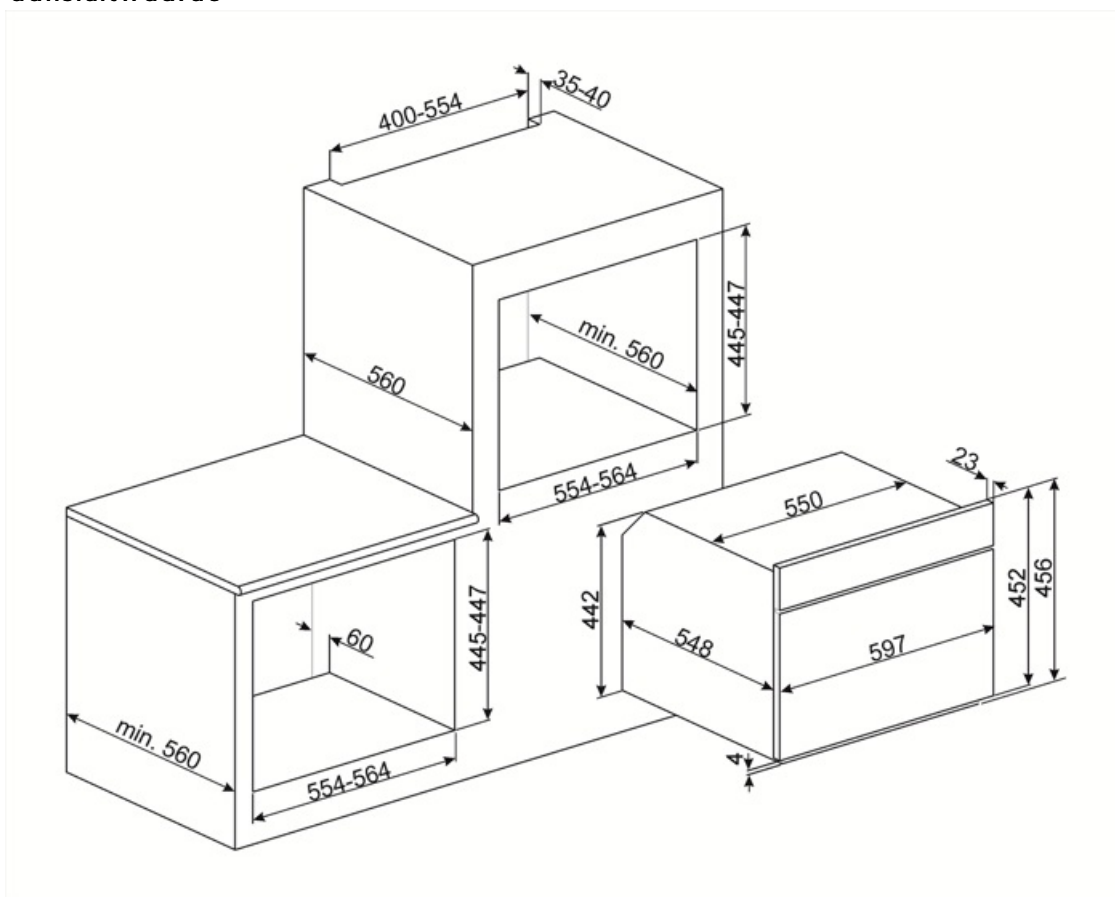

---

## Compatibele Accessoires

---

### BN620-1

Geëmailleerde bakplaat, 20 mm diep



### PALPZ

Pizzaschep met inklapbare handgreep  
breedte: 315 mm lengte: 325 mm



### BN640

Geëmailleerde bakplaat, 40 mm diep





























### PR3845X

Antifingerprint roestvrij staal.  
Afdekstrip voor meubels in  
kolominstallatie van meer ovens



## Symbols glossary

 <p>Kinderslot: sommige modellen zijn voorzien van een apparaat om het programma / de cyclus te vergrendelen zodat het niet kan per ongeluk veranderd</p>	 <p>Combination microwave: This oven allows to combine two different ways of cooking (Traditional with microwaves). Combined ovens increase cooking opportunities, while providing maximum flexibility of household appliances.</p>
 <p>Luchtkoelsysteem: om een veilig oppervlak te garanderen temperaturen.</p>	 <p>Ontdooien op tijd: met deze functie wordt automatisch het tijdstip van ontdooien van voedsel bepaald</p>
 <p>Ontdooien op gewicht: Met deze functie wordt de ontdooitijd bepaald</p>	 <p>Deuren met driedubbele beglazing: aantal glazen deuren.</p>
 <p>Electric</p>	 <p>Geëmailleerde binnenkant: De geëmailleerde binnenkant van alle Smeg-ovens heeft een speciale antacidumvoering die helpt om de binnenkant schoon te houden door de hoeveelheid kookvet te verminderen.</p>
 <p>Ventilator met bovenste en onderste elementen: de elementen in combinatie met de ventilator zijn bedoeld om een meer gelijkmatige warmte te bieden, een methode die vergelijkbaar is met conventioneel koken, dus voorverwarmen is vereist. Het meest geschikt voor items die langzaam koken vereisen.</p>	 <p>Circulaire: it is the perfect function for cooking all types of dishes in a more delicate way. The heat comes from the back of the oven and is distributed quickly and evenly The fan is active. It is also ideal for cooking on multiple levels without mixing smells and flavors.</p>
 <p>De warmte wordt geproduceerd door het grill- en bovenelement. Verhitting over het volledige oppervlak. De thermostaat wordt, afhankelijk van het gerecht, in de regel op de maximale stand gezet. Bij een korte baktijd kan de oven gesloten blijven; bij langere baktijd blijft deze gedeeltelijk geopend. Voor vleesgerechten (klein- en middelgroot), vleespennen, vis, groenten, gratineren etc.</p>	 <p>Microwave: Penetrating straight into the food, microwaves cook very quickly and with considerable energy savings. Suitable for cooking without fat, they are also able to thaw and heat food without altering its original appearance and aroma. The microwave function can also be combined with conventional functions with all the resulting advantages. Ideal for all types of food.</p>
 <p>Cooking with the simultaneous use of the heating element in combination with fan and microwave supply.</p>	 <p>Microwave + grill element: The use of the grill results in a perfect browning of the surface of the food. The action of microwaves allows instead of cooking in a short time the internal part of the food.</p>
 <p>Fan combined with traditional cooking, where heat is generated from above and below, provides uniform heat. Adding the microwave function allows the same cooking results in less time.</p>	 <p>Compact appliances with a height of 45 cm - perfect solution to meet the functional requirements of kitchen sets of small height. Available in several types and in different styles.</p>
 <p>KEEP_WARM_72dpi</p>	 <p>verlichting</p>
 <p>ECO-logic: option allows you to restrict the power limit of the appliance real energy saving.</p>	 <p>Rapid preheating: cooking is preceded by the preheating phase which allows the cooking compartment to reach the set temperature. This option reduces the time by up to 50%.</p>

- 
-  The oven cavity has 3 different cooking levels.
  -  Electronic control: Allows you to maintain temperature inside the oven with the precision 2-3 ° C. This enables to cook meals that are very sensitive to temperature changes, such as cakes, souffles, puddings.
  -  Vapor Clean: a simple cleaning function using steam to loosen deposits in the oven cavity.
  -  The capacity indicates the amount of usable space in the oven cavity in litres.
  -  Soft close: all models are equipped with advanced function of smooth closing of the door, which allows the device to close smoothly and quietly.
  -  Tilting grill: the tilting grill can be easily unhooked to move the heating element and clean the roof of the appliance in one simple step.
  -  The capacity indicates the amount of usable space in the oven cavity in litres.